

中国高品质滴灌制造商

- 畅销60个国家
- 国家权威机构认证
- 荣获30多项技术专利

2023

厦门华最灌溉设备科技有限公司
Chinadrip Irrigation Equipment Co.,Ltd.

公司简介 | COMPANY PROFILE

公司创立于 2006 年，一直专注于农业节水灌溉设备的研发，生产和销售。

目前主要产品有压力补偿滴灌系统、过滤器系统、控制阀、空气阀及相关配件；可广泛应用于农业大田灌溉，温室大棚，园林景观和市政绿化等；

当前公司厂房面积 2 万多平方米，设有研发工程部、模具车间、注塑车间、挤出车间、自动化及产品测试等现代化车间，并已通过 ISO9001 质量体系认证。

良好的生产设施和优异的团队，以及十多年来专注和积累，为确保产品质量稳定奠定基础。目前公司产品已畅销 60 多个国家和地区，得到国内外众多用户的认可，华最已成为行业知名品牌。

华最做灌溉行业专家，助力农民增产丰收！

We are always focusing on the research and development, production and sales of irrigation equipment since 2006

Our Products Line

Our products include PC drip irrigation system, Filter system, Controlling Valve, Air valve, Tubing and Fittings etc. They are all manufactured by advanced technology and good quality materials which can be applied widely in agriculture irrigation, landscape, family garden, sports facility and so on.

Our Production Facilities

At present, our company has a workshop area of more than 20,000 square meters, with research and development engineering department, mold workshop, injection molding workshop, extrusion workshop, automation and product testing and other modern workshops, and also has passed the ISO9001 Quality System Certification.

Our Advantage

Good production facilities and excellent team, as well as more than ten years of focus and experience is to ensure the stability of product quality. At present, our products have sold well in more than 60 countries and regions, and have been recognized by many users at home and abroad. Chinadrip has become a well-known brand in the line.

Our Mission:

In improving quality continuously, we trust.

In providing best service continuously, we trust.

In being your partner to win to win, we trust.



● 照片墙 ●



水利部节水灌溉设备质量检测中心
检验报告

(节灌溉检)字 第 N62020101204 号 第 2 页 共 2 页

检测结论:
 样品名称 压力补偿式滴头 样品数量 30 个
 规格型号 3L/h 样品颜色 红色、蓝色
 检验依据 GB/T19812.2-2017 检验日期 2020-10-13
 样品编号 N62020101204 工作压力 100-1000kPa

序号	检测项目	技术要求	检测结果
1	外观	表面应光滑、无毛刺、无裂纹、无油污、无锈迹、无变形、无损伤、无缺陷。	符合标准要求
2	平均流量	滴头流量误差	-5.7%
3	流量调节系数 C _v	流量调节系数	2.0%
4	滴头流量系数 K _d	滴头流量系数	0.03
5	工作压力范围, kPa	工作压力	400

流量与流量系数关系图

报告编写人: 审核: 检测负责人: (盖章)

水利部节水灌溉设备质量检测中心
检验报告

(节灌溉检)字 第 N62020101205 号 第 2 页 共 2 页

检测结论:
 样品名称 压力补偿式滴头 样品数量 30 个
 规格型号 3L/h 样品颜色 红色、蓝色
 检验依据 GB/T19812.2-2017 检验日期 2020-10-14
 样品编号 N62020101205 工作压力 100-1000kPa

序号	检测项目	技术要求	检测结果
1	外观	表面应光滑、无毛刺、无裂纹、无油污、无锈迹、无变形、无损伤、无缺陷。	符合标准要求
2	平均流量	滴头流量误差	-2.0%
3	流量调节系数 C _v	流量调节系数	2.7%
4	滴头流量系数 K _d	滴头流量系数	0.03
5	工作压力范围, kPa	工作压力	400

流量与流量系数关系图

报告编写人: 审核: 检测负责人: (盖章)

水利部节水灌溉设备质量检测中心
检验报告

(节灌溉检)字 第 N62020101206 号 第 2 页 共 2 页

检测结论:
 样品名称 压力补偿式滴头 样品数量 30 个
 规格型号 3L/h 样品颜色 红色
 检验依据 GB/T19812.2-2017 检验日期 2020-10-14
 样品编号 N62020101206 工作压力 100-1000kPa

序号	检测项目	技术要求	检测结果
1	外观	表面应光滑、无毛刺、无裂纹、无油污、无锈迹、无变形、无损伤、无缺陷。	符合标准要求
2	平均流量	滴头流量误差	-2.0%
3	流量调节系数 C _v	流量调节系数	2.5%
4	滴头流量系数 K _d	滴头流量系数	0.03
5	工作压力范围, kPa	工作压力	400

流量与流量系数关系图

报告编写人: 审核: 检测负责人: (盖章)

水利部节水灌溉设备质量检测中心
检验报告

(节灌溉检)字 第 N62020201501 号 第 2 页 共 2 页

检测结论:
 样品名称 压力补偿式滴灌管 样品数量 30 米
 规格型号 200×1.2 工作压力 100-1000kPa
 检验依据 GB/T19812.2-2017 检验日期 2020-10-14
 样品编号 N62020201501 工作压力 100-1000kPa

序号	检测项目	技术要求	检测结果
1	外观	表面应光滑、无毛刺、无裂纹、无油污、无锈迹、无变形、无损伤、无缺陷。	符合标准要求
2	平均流量	滴灌管流量误差	符合标准要求
3	流量调节系数 C _v	流量调节系数	符合标准要求
4	滴头流量系数 K _d	滴头流量系数	符合标准要求
5	滴头流量系数 K _d	滴头流量系数	符合标准要求
6	滴头流量系数 K _d	滴头流量系数	符合标准要求
7	滴头流量系数 K _d	滴头流量系数	符合标准要求
8	滴头流量系数 K _d	滴头流量系数	符合标准要求
9	滴头流量系数 K _d	滴头流量系数	符合标准要求
10	滴头流量系数 K _d	滴头流量系数	符合标准要求
11	滴头流量系数 K _d	滴头流量系数	符合标准要求
12	滴头流量系数 K _d	滴头流量系数	符合标准要求
13	滴头流量系数 K _d	滴头流量系数	符合标准要求

流量与流量系数关系图

报告编写人: 审核: 检测负责人: (盖章)

水利部节水灌溉设备质量检测中心
检验报告

(节灌溉检)字 第 N62020201703 号 第 2 页 共 2 页

检测结论:
 样品名称 压力补偿式滴灌管 样品数量 30 米
 规格型号 200×1.2 工作压力 100-1000kPa
 检验依据 GB/T19812.2-2017 检验日期 2020-10-14
 样品编号 N62020201703 工作压力 100-1000kPa

序号	检测项目	技术要求	检测结果
1	外观	表面应光滑、无毛刺、无裂纹、无油污、无锈迹、无变形、无损伤、无缺陷。	符合标准要求
2	平均流量	滴灌管流量误差	符合标准要求
3	流量调节系数 C _v	流量调节系数	符合标准要求
4	滴头流量系数 K _d	滴头流量系数	符合标准要求
5	滴头流量系数 K _d	滴头流量系数	符合标准要求
6	滴头流量系数 K _d	滴头流量系数	符合标准要求
7	滴头流量系数 K _d	滴头流量系数	符合标准要求
8	滴头流量系数 K _d	滴头流量系数	符合标准要求
9	滴头流量系数 K _d	滴头流量系数	符合标准要求
10	滴头流量系数 K _d	滴头流量系数	符合标准要求
11	滴头流量系数 K _d	滴头流量系数	符合标准要求
12	滴头流量系数 K _d	滴头流量系数	符合标准要求
13	滴头流量系数 K _d	滴头流量系数	符合标准要求

流量与流量系数关系图

报告编写人: 审核: 检测负责人: (盖章)

水利部节水灌溉设备质量检测中心
检验报告

(节灌溉检)字 第 N62020201501 号 第 2 页 共 2 页

检测结论:
 样品名称 压力补偿式滴灌管 样品数量 30 米
 规格型号 200×1.2 工作压力 100-1000kPa
 检验依据 GB/T19812.2-2017 检验日期 2020-10-14
 样品编号 N62020201501 工作压力 100-1000kPa

序号	检测项目	技术要求	检测结果
1	外观	表面应光滑、无毛刺、无裂纹、无油污、无锈迹、无变形、无损伤、无缺陷。	符合标准要求
2	平均流量	滴灌管流量误差	符合标准要求
3	流量调节系数 C _v	流量调节系数	符合标准要求
4	滴头流量系数 K _d	滴头流量系数	符合标准要求
5	滴头流量系数 K _d	滴头流量系数	符合标准要求
6	滴头流量系数 K _d	滴头流量系数	符合标准要求
7	滴头流量系数 K _d	滴头流量系数	符合标准要求
8	滴头流量系数 K _d	滴头流量系数	符合标准要求
9	滴头流量系数 K _d	滴头流量系数	符合标准要求
10	滴头流量系数 K _d	滴头流量系数	符合标准要求
11	滴头流量系数 K _d	滴头流量系数	符合标准要求
12	滴头流量系数 K _d	滴头流量系数	符合标准要求
13	滴头流量系数 K _d	滴头流量系数	符合标准要求

流量与流量系数关系图

报告编写人: 审核: 检测负责人: (盖章)

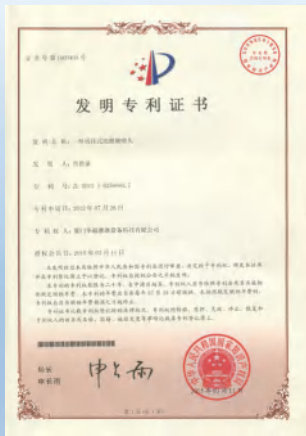
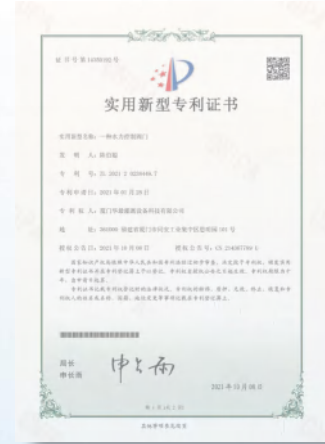

滴灌产品 Drip Irrigation

- 02 压力补偿滴灌带 / 管 PC Drip tape (DripLine) with AS
- 05 压力补偿滴头 Dripper with PC
- 07 可拆式压力补偿滴头 Take Apart PC Dripper
- 08 滴箭及其配件 Dripper Stake and Accessory

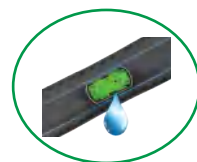
**微喷产品 Microsprinkler**

- 10 可调喷头 Adjustable Bubbler
- 13 补偿式涌泉喷头 PC Bubbler
- 15 补偿式涡流喷头 Full Circle PC Sprayer
- 17 压力补偿微喷头 PC Microsprinkler
- 19 旋转微喷头 Microsprinkler
- 20 雾化喷头 Fogger
- 21 微喷头配件 Accessory for Microsprinkler

**过滤器 Plastic Filter**

- 23 T 自动反冲洗过滤系统 T Automatic Self-Clean Filtration System
- 25 H 自动反冲洗过滤系统 H Automatic Self-Clean Filtration System
- 27 自动反冲洗叠片过滤器 Automatic Self-Cleaning Disc Filter
- 29 手动叠片过滤器 Manual Disc Filter
- 31 Y 型小型过滤器 Y Type Micro Filter
- 32 过滤器反冲洗阀 Filter Backwash Hydraulic Valve
- 34 自动过滤系统控制器 Controller for Automatic Self-Clean Filtration System

**水力控制阀 Hydraulic Controlling Valve**

- 35 电磁头 (电机式) Solenoid Valve (Motor Type)
- 37 水力控制阀主阀 Plastic Hydraulic Control Main Valve
- 39 电磁开关阀 Solenoid Valve for ON/OFF Control
- 40 减压阀 Pressure Reducing Valve
- 41 水力控制阀其他应用 Other Hydraulic Control Valve

**微灌用其它配件 Other Accessory for Microirrigation**

- 42 C 型组合式空气阀 C Type Combination Air Valve
- 44 K 型快速进排气阀 K Type Kinetic Air Valve
- 46 G 型快速进排气阀 G Type Kinetic Air Valve
- 48 空气阀 Air and Vacuum Release Valve
- 50 文丘里注肥器 Venturi Fertilizer Injector

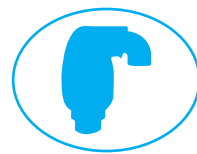
**微灌管及其配件 Tubing and Fitting for Microirrigation**

- 52 LDPE 软管 LDPE Tubing
- 53 拉扣式滴灌带用配件 Lock Ring Fitting for Drip Tape
- 53 锁扣式滴灌带用配件 Lock Nut Fitting for Drip Tape
- 54 滴灌带用阀门 Mini Valve for Drip Tape
- 55 微灌管用配件 Fitting for Tubing
- 56 Dn16 锁扣管用配件 Lock Nut Fitting for Pipe
- 57 Dn20 锁扣管用接头 Lock Nut Fittings for Dn20 Pipe
- 58 微灌管用阀门 Mini Valve for Tubing



PC100 防倒吸压力补偿滴灌带 (管) PC100 Pressure Compensating Driptape (Dripline) with Anti-Siphon

特点 Features:

- PC100 压力补偿滴灌带 (管) 为一次性挤出成型, 内置压力补偿滴头, 无需再人工安装滴头, 铺设施工方便省力。
- 内镶压力补偿滴头带有迷宫流道, 结构科学, 硅胶片质量稳定, 压力补偿效果好。
- 内镶滴头自带超长过滤进水口, 抗堵塞性能好, 使用寿命长。
- 内镶滴头同时具有防倒吸功能, 防止杂物吸入流道, 可用于地埋灌溉。
- 内镶滴头制造偏差小, 出水流量均匀, 铺设长度长。
- 采用优质材料和先进生产工艺, 耐腐蚀, 抗老化, 经久耐用。
- PC100 Driptape (Dripline) produced by extrusion with PC emitter inside which save the time for installation.
- With new type of labyrinth passages, scientific structure, and good quality of silicon diaphragm for high efficient pressure compensating.
- Self-flushing system with wide filtration area of inlet improves the resistance of clogging for long life.
- Emitter has the function of Anti-siphon which can prevent the small varia into the channel of emitter, so this PC driptape can be used for SDI.
- With superior CV and excellent uniformity for long length of laying run.
- Produced by high quality material and advanced technology, better for anti-corrosion and anti-ageing.

应用 Application:

- 工作压力范围 0.5-3.5Bar.
- 推荐过滤等级: 120 目以上。
- 铺设整齐平直, 地面铺设出水口朝上。
- 适用丘陵和山地种植及多年生作物。
- Working pressure: 0.5-3.5Bar.
- Filtration Required: Above 120mesh.
- Lay in line and levelly, all the holes of emitter must be upward.
- Suitable for the planing on hills and mountains, or Sub-surface multi seasonal row crop.



滴头规格 Specification of Emitter:

压力 VS 流量表 Pressure VS Flowing	压力 Pressure (Bar)	流量 Flow Rate (L/h)		
		1.0L/h	1.6L/h	2.0L/h
	0.5	1.02	1.55	1.95
	1.0	1.03	1.60	2.10
	2.0	1.05	1.65	2.15
	3.0	1.04	1.70	2.20
	3.5	1.01	1.62	2.10



1.0L/H



1.6L/H



2.0L/H

PC100 滴灌管 Dn16 规格 Specification for Dn16 PC dripline.

Picture	Item No.	Diameter (mm)	Thickness	Emitter Spacing (cm)	Flowing (L/H)	Package (m/roll)
	PCAS0116402010/16/20	16	0.4mm (16mil)	20	1.0/1.6/2.0	700
	PCAS0116403010/16/20			30		700
	PCAS0116404010/16/20			40		800
	PCAS0116405010/16/20			50		800
	PCAS0116603010/16/20	16	0.6mm (24mil)	30	1.0/1.6/2.0	500
	PCAS0116604010/16/20			40		500
	PCAS0116605010/16/20			50		500
	PCAS01166010010/16/20			100		500

PC100 滴灌管 Dn16 规格 Specification for Dn16 PC dripline.

Picture	Item No.	Diameter (mm)	Thickness	Emitter Spacing (cm)	Flowing (L/H)	Package (m/roll)
	PCAS0116802010/16/20	16	0.8mm (32mil)	20	1.0/1.6/2.0	500
	PCAS0116803010/16/20			30		500
	PCAS0116804010/16/20			40		500
	PCAS0116805010/16/20			50		500
	PCAS01168010010/16/20			100		500
	PCAS01161002010/16/20	16	1.0mm (40mil)	20	1.0/1.6/2.0	500
	PCAS01161003010/16/20			30		500
	PCAS01161004010/16/20			40		500
	PCAS01161005010/16/20			50		500
	PCAS011610010010/16/20			100		500

PC100 滴灌管 Dn20 规格 Specification for Dn20 Dripline:

Picture	Item No.	Diameter (mm)	Thickness	Emitter Spacing (cm)	Flowing (L/H)	Package (m/roll)
	PCAS01201002010/16/20	20	1.0mm (40mil)	20	1.0/1.6/2.0	300
	PCAS01201003010/16/20			30		300
	PCAS01201004010/16/20			40		300
	PCAS01201005010/16/20			50		300
	PCAS012010010010/16/20			100		300
	PCAS01201202010/16/20	20	1.2mm (48mil)	20	1.0/1.6/2.0	300
	PCAS01201203010/16/20			30		300
	PCAS01201204010/16/20			40		300
	PCAS01201205010/16/20			50		300
	PCAS012012010010/16/20			100		300

Dn16 最长铺设长度 Maximum Length of Run:

滴头流量 Flow Rate: 1.0L/h 地势平坦 Flat Terrain 前后流量偏差 Flowing Variation 10%					
进水压力 (Bar) Inlet Pressure	滴头间距 Spacing Between Emitters (cm) VS 铺设长度 Length Run (m)				
	20	30	40	50	100
1.0	90	125	160	190	320
1.5	110	155	200	235	405
2.0	125	180	225	270	460
2.5	135	195	250	300	510
3.0	150	210	270	320	540

滴头流量 Flow Rate: 1.6L/h 地势平坦 Flat Terrain 前后流量偏差 Flowing Variation 10%					
进水压力 (Bar) Inlet Pressure	滴头间距 Spacing Between Emitters (cm) VS 铺设长度 Length Run (m)				
	20	30	40	50	100
1.0	60	90	120	140	240
1.5	80	110	140	170	300
2.0	90	130	160	195	330
2.5	100	140	175	215	375
3.0	110	150	190	230	410

滴头流量 Flow Rate: 2.0L/h 地势平坦 Flat Terrain 前后流量偏差 Flowing Variation 10%					
进水压力 (Bar) Inlet Pressure	滴头间距 Spacing Between Emitters (cm) VS 铺设长度 Length Run (m)				
	20	30	40	50	100
1.0	55	80	100	120	200
1.5	70	95	125	150	250
2.0	80	110	140	170	285
2.5	85	120	155	185	320
3.0	90	130	165	200	345

Dn20 最长铺设长度 Maximum Length of Run:

滴头流量 Flow Rate: 1.0L/h 地势平坦 Flat Terrain 前后流量偏差 Flowing Variation 10%					
进水压力 (Bar) Inlet Pressure	滴头间距 Spacing Between Emitters (Cm) VS 铺设长度 Length Run (m)				
	20	30	40	50	100
1.0	150	210	260	300	490
1.5	180	260	320	370	610
2.0	210	290	360	430	700
2.5	230	320	400	470	780
3.0	250	340	430	510	850

滴头流量 Flow Rate: 1.6L/h 地势平坦 Flat Terrain 前后流量偏差 Flowing Variation 10%					
进水压力 (Bar) Inlet Pressure	滴头间距 Spacing Between Emitters (Cm) VS 铺设长度 Length Run (m)				
	20	30	40	50	100
1.0	110	150	190	220	360
1.5	130	180	230	270	450
2.0	150	210	260	320	520
2.5	170	240	290	350	570
3.0	190	270	310	380	620

滴头流量 Flow Rate: 2.0L/h 地势平坦 Flat Terrain 前后流量偏差 Flowing Variation 10%					
进水压力 (Bar) Inlet Pressure	滴头间距 Spacing Between Emitters (Cm) VS 铺设长度 Length Run (m)				
	20	30	40	50	100
1.0	90	130	160	190	320
1.5	110	160	200	240	390
2.0	130	180	230	270	450
2.5	150	200	250	300	500
3.0	160	220	270	320	540

管上式自清洗压力补偿滴头 Compact Online PC Dripper with Self-cleaning

特点 Features:

- 内置新一代迷宫式宽流道，全程自清洗，进水口带过滤格栅，抗堵塞性能好。
- 采用进口优质硅胶生产膜片，压力补偿效果好；同时稳定性强，使用寿命长。
- 使用 100% 优质塑料原料和添加剂生产，耐腐蚀，耐老化，抗紫外线强。
- 采用先进生产工艺，制造偏差 CV 小，确保每个滴头出水均匀。
- 结构紧凑，体积小，对田间机械作业影响小。
- 有 2 种出水口接头，带倒刺接头可直接接毛管用于 1 出 1 滴箭，节省配件，
- 安装方便；带承插接头可配合 1 出 4 或 1 出 2 滴箭套件。
- Wide and deep water passgers of labyrinth inside dripper and Continuous self- flushing improve clogging resistance.
- Diaphragm inside dripper made by excellent silicon gel is good for effect of pressure compensation and stability with long service life.
- Produced by Good Quality of Raw plastic material and additive insure anti-corrosion, anti-UV and anti-aging well.
- Adopting advanced production technology with very low CV, which ensure that the flowing of each dripper is nearly same.
- Uniform discharges as high efficiency of PC , which is good at irrigation for the area of undulating terrain.
- Compact structure with small volume, which is convenient for the operation of field machinery .
- With 2 different outlet, barb is suitable for one branch of Dripper stake, and nipple is connected with 2 or 4 branch dripper stake.
- No-Drain models can reduce the leakage of dipper in uneven terrain and overhead drip applications.



应用范围 Application:

- 有普通和防滴式二种规格：
- 普通款出水压力低，水头损失小，补偿范围 0.5-4.0Bar，主要用于大田灌溉，花卉，灌木，果树及园林景观。
- 防滴式封水压力为 0.15bar，补偿范围 0.7-4.0Bar，主要用于温室大棚等设施农业精准灌溉，确保开关时每个滴头出水一致；另外在坡度较大地方使用可避免低洼地积水。
- 现有 2L/h、4L/h、8L/h、12L/h、16L/h 和 25L/h 六种流量选择，满足不同灌溉需求。
- 推荐过滤等级：120 目。
- Two type dripper available, Common and Anti-drain:
- Common type with low pressure of outlet flowing, small head lose and the range of PC is 0.5-4.0bar.Suitable for field irrigation, shrubbery,fruit tree and landscape.
- Anti-drain type seals at 0.15bar , and range of Pc is 0.7-4.0bar,Suitable for Greenhouse,nurseries and other precision irrigation, to sure that each dripper can be flowing and stopped in same time.
- Six different flowing available, 2L/h,4L/h,8L/h,12L/h, 16L/h and 25L/h to meet different requirement.
- Recommended filtration: 130 micron / 120 mesh.

技术参数 Technical Data:

压力 VS 流量曲线 Pressure VS Flow Curve	工作压力 Working Pressure (Bar)	流量 Flow Rate (L/h)					
		PCD0202B/N PCND0202B/N	PCD0204B/N PCND0204B/N	PCD0208B/N PCND0208B/N	PCD0212B/N PCND0212B/N	PCD0216B/N PCND0216B/N	PCD0225B/N PCND0225B/N
	0.5	1.9	3.9	7.8	11.9	15.8	—
	0.7	2.0	4.0	7.9	12.1	16.1	—
	1.0	2.1	4.1	8.0	12.0	16.3	23.5
	2.0	2.1	4.2	8.2	12.2	15.9	24.8
	3.0	2.2	4.1	8.3	12.1	16.3	25.7
	4.0	2.1	4.0	8.1	12.3	16.2	26.5

管上式压力补偿滴头 PC Online Dripper

产品名称 Product Description	图片 Picture	货号 Item No.	流量 Size	每袋数量 Qty/Bag (Pc)	每箱数量 Qty/Ctn (Pc)	纸箱规格 Ctn Size (Cm)
普通式压力补偿滴头 Common PC Dripper		PCD0202B/N	2L/h	1000	12000	54*35*28
		PCD0204B/N	4L/h	1000	12000	54*35*28
		PCD0208B/N	8L/h	1000	12000	54*35*28
		PCD0212B/N	12L/h	1000	12000	54*35*28
		PCD0216B/N	16L/h	1000	12000	54*35*28
		PCD0225B/N	25L/h	1000	12000	54*35*28
防滴式压力补偿滴头 No-drain PC Dripper		PCND0202B/N	2L/h	1000	12000	54*35*28
		PCND0204B/N	4L/h	1000	12000	54*35*28
		PCND0208B/N	8L/h	1000	12000	54*35*28
		PCND0212B/N	12L/h	1000	12000	54*35*28
		PCND0216B/N	16L/h	1000	12000	54*35*28
		PCND0225B/N	25L/h	1000	12000	54*35*28

* 备注: 货号后 B 代表 Bard, 表示出水口为倒刺接头, 货号后 N 代表 Nipple, 表示出水口为承插接头。

* Note: Item No. with "B" means dripper with Barb outlet connection. "N" means dripper with Nipple connection.

可拆式压力补偿滴头 Take Apart PC Dripper

特点 Features:

- 流量均匀，压力补偿效果好，可适用于地势起伏较大的坡地或丘陵地带。
- 滴头面盖可以打开，易于检查和清洗。
- 制造偏差 CV 小，确保每个滴头出水量一致。
- 采用优质塑料生产，耐化学腐蚀，抗紫外线，抗老化。
- Uniform discharges as high efficiency of PC, which is good at irrigation for the area of undulating terrain.
- This dripper can be opened to clean and check and can be used for long time.
- Low manufacturing CV values, the flow rate of each dripper is almost same.
- Produced by Good Quality of Raw plastic material with Anti-corrosion, Anti-UV and Anti-aging.

应用范围 Application:

- 压力补偿范围：0.7-3.5bar 过滤等级：120 目。
- 适用于果树，灌木丛，花圃及其他作物。
- 有 2L/h, 4L/h, 8L/h 三种流量选择，满足不同灌溉需求。
- Working Pressure: 0.7-3.5bar Filtration: Above 120mesh.
- Suitable for shrubbery, Flower garden, Fruit tree and other planting.
- Three type flowing available 2L/h, 4L/h and 8L/h to meet different requirement.



产品名称 Product Description	图片 Picture	货号 Item No.	规格 Size	每袋数量 Qty/Bag (Pc)	每箱数量 Qty/Ctn (Pc)	纸箱规格 Ctn Size (Cm)	毛重 G.W (Kg)
可拆式压力补偿滴头 Take Apart PC Dripper		PCT0102	2L/h	500	4500	54*35*28	17
		PCT0104	4L/h	500	4500	54*35*28	17
		PCT0108	8L/h	500	4500	54*35*28	17

技术参数 Technical Data:

压力 VS 流量曲线 Q(L/h)	工作压力		流量 Discharge(L/h)		
	Working Preaaure (Bar)	PCT0102	PCT0104	PCT0108	
	0.7	1.8	3.5	7.4	
	1.0	2.2	4.1	8.0	
	1.5	2.3	4.2	8.5	
	2.0	2.4	4.3	8.7	
	2.5	2.2	4.4	8.9	
	3.0	2.1	4.1	8.5	
	3.5	1.9	3.8	8.3	

滴箭 / 插箭 Dripper Stake / Support Stake

特点 Features:

- 连接滴头，可插入土壤或栽培基质中固定导流。
- 滴箭带迷宫流道，水量分配均匀。
- 入水口自带过滤网格，抗堵塞性能强。
- 采用优质塑料，不易折断，耐化学腐蚀。
- Easy to fix the location in soil for irrigation with their stick.
- Turbulent flowing with the labyrinth of passageways, and uniform flowing.
- Good for clogging resistant with filter net inlet.
- Produced by good quality of plastic material with Anti-corrosion and not broken.



应用范围 Application:

- 工作压力：0.2-2.0bar 过滤等级：120目。
- 有弯滴箭和加长弯滴箭两种规格可供选择，满足不同作物需求。
- 与 Dn5/3PVC 毛管连接，有 1 出，2 出和 4 出等多种组合。
- 适用于盆栽植物、苗木及立体绿化等作物灌溉。
- Working pressure: 0.2-2.0bar Minimum Filtration: 120mesh.
- Bending and super bending two type available to meet different requirement.
- Connecting with Dn5/3 PVC soft pipe with several combinatorial method.
- Suitable for shrubbery, Pottings and three-dimensional plantings.

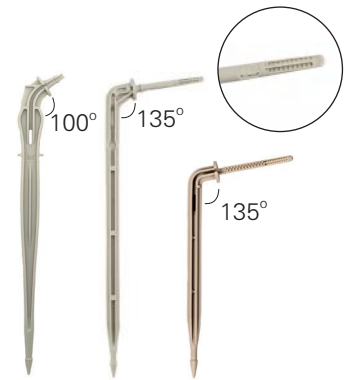

产品名称 Product Description	图片 Picture	货号 Item No.	规格 Size	每袋数量 Qty/Bag (Pc)	每箱数量 Qty/Ctn (Pc)	纸箱规格 Ctn Size (Cm)	毛重 G.W (Kg)
插箭 Support Stake		2151	15Cm Length	散装 In Bulk	5000	66*31*40	12
短弯滴箭 Dripper Stake		2102	2.2L/h 10Cm Length	散装 In Bulk	5000	66*31*40	12
长弯滴箭 Dripper Stake		2152	2.2L/h 15Cm Length	散装 In Bulk	2500	66*31*40	8

技术参数 Technical Data:

货号 Item No.	工作压力 VS 流量 Working Preaature (Bar) VS Discharge(L/h) CV ≤ 5%										流态指数 Flow Index
	0.2Bar	0.4Bar	0.6Bar	0.7Bar	1.0Bar	1.2Bar	1.4Bar	1.6Bar	1.8Bar	2.0Bar	
2102	0.9	1.5	1.7	2.0	2.2	2.4	2.7	2.9	3.2	3.4	$Q=2.2H^{0.548}$
2152	0.9	1.4	1.7	2.0	2.2	2.4	2.6	2.7	2.9	3.1	$Q=2.2H^{0.516}$

滴箭套装 Dripper Stake Kits

产品名称 Product Description	图片 Picture	货号 Item No.	规格 Size	每袋数量 Qty/Bag (Pc)	每箱数量 Qty/Ctn (Pc)	纸箱规格 Ctn Size (Cm)	毛重 G.W (Kg)
一出插箭套装 1way Stake Kit		21511	50CM*1	10	1500	66*31*40	16
一出插箭套装配黑白 PE 管 1way Stake Kit with W/B PE pipe		W21511	50CM*1	10	1500	66*31*40	16
二出滴箭套装 2way Dripper Stake Kit		2122B	50CM*2 Dn4	10	700	66*31*40	12
二出滴箭套装配黑白 PE 管 2way Dripper Stake Kit with W/B PE pipe		W2122B	50CM*2 Dn5	10	700	66*31*40	12
四出滴箭套装 4way Dripper Stake Kit		2142B	50CM*4 Dn4	10	350	66*31*40	12
四出滴箭套装配黑白 PE 管 4way Dripper Stake Kit with W/B PE pipe		W2142B	50CM*4 Dn5	10	350	66*31*40	12
二出长滴箭套装 2way Long Dripper Stake Kit		21522B	50CM*2 Dn4	10	400	66*31*40	10
二出长滴箭套装配黑白 PE 管 2way Long Dripper Stake Kit with W/B PE pipe		W21522B	50CM*2 Dn5	10	400	66*31*40	10
四出长滴箭套装 4way Long Dripper Stake Kit		21524B	50CM*4 Dn4	10	200	66*31*40	10
四出长滴箭套装配黑白 PE 管 4way Long Dripper Stake Kit with W/B PE pipe		W21524B	50CM*4 Dn5	10	200	66*31*40	10

一出插箭套装 1 Way Kit

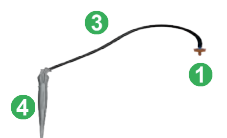

二出滴箭套装 2 Way Kit

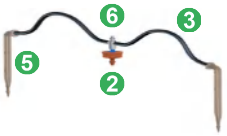

四出滴箭套装 4 Way Kit

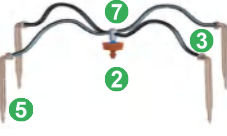

360° 可调式涌泉喷头 Adjustable Bubbler



特点 Features:

- 流量和灌溉范围可调节，旋转面盖可调节流量和喷洒覆盖面。
- 滴头面盖可以打开，易于检查和清洗。
- 其中 AOD0170B 带倒刺旁通，可直接打孔安排在 Dn12-32PE 管上，易于安装维护。
- 其中 AOD0170H 带地插，可以与 Dn5/3mmPVC(或 Dn6mmPE) 毛管联接，任意定点地插在作物附近。
- 采用优质塑料，耐化学腐蚀，抗紫外线，抗老化。
- Flowing and Spraying Radius can be adjusted by turning the cover of dripper.
- Easy to remove the cover of dripper for inpection and cleaning.
- Easy for installation, AOD0170B can be inserted onto Dn12-32mm PE pipe directly with its Barb offtake.
- AOD0170H can be connected with Dn5/3mm pvc (or Dn6mm PE) tubing and easy to stick near the planing with its spike .
- Produced by Good Quality of Raw plastic material with Anti-corrosion, Anti-UV and Anti-aging.

应用范围 Application:

- 流量调节范围广，可适用在地形起伏不定的灌溉区域。
- 适用于灌木丛，苗圃，果树及盆栽等作物。
- With large range of adjustment for flowing, good at irrigation of uneven terrain.
- Suitable for shrubbery, Nursery garden, Fruit tree, Pottings and other planting.



产品名称 Product Description	图片 Picture	货号 Item No.	规格 Size	每袋数量 Qty/Bag (Pc)	每箱数量 Qty/Ctn (Pc)	纸箱规格 Ctn Size (Cm)	毛重 G.W (Kg)
360° 可调式 涌泉喷头 Adjustable Bubbler		AOD0170B	0-70L/h@1Bar	500	8000	54*35*28	14
360° 可调式 地插涌泉喷头 Adjustable Bubbler with Spiker		AOD0170H	0-70L/h@1Bar 15cm Length	100	1200	54*35*28	9

360° 可调涡流喷头 Adjustable Flow Sprayer



特点 Features:

- 涡流全圆式喷洒，增添景观效果。
- 旋转面盖可调节流量和喷洒范围。
- 面盖可以打开，易于检查和清洗。
- 其中 AS0180B 带倒刺旁通，可直接打孔安排在 Dn12-32PE 管上，易于安装维护。
- 其中 AS0180H 带地插，可以与 Dn5/3mmPVC(或 Dn6mmPE) 毛管联接，任意定点地插在作物附近。
- 采用优质工程塑料，耐化学腐蚀，抗紫外线，抗老化。
- Full circle sprayer with fine water droplets, also beauty landscape.
- Flowing and Spraying Radius can be adjusted by turning the cover of sprayer.
- Easy to remove the cover of dripper for inpection and cleaning.
- Easy for installation, AS0180B can be inserted onto Dn12-32mm PE pipe directly with its Barb offtake .
- AS0180H can be connected with Dn5/3mm pvc (or Dn6mm PE) tubing and easy to stick near the planing with its spike.
- Produced by Good Quality of Raw plastic material with Anti-corrosion, Anti-UV and Anti-aging.

应用范围 Application :

- 流量调节范围广，可适用在地形起伏不定的灌溉区域。
- 适用于灌木丛，苗圃，果树及盆栽等作物。
- With large range of adjustment for flowing, good at irrigation of uneven terrain.
- Suitable for shrubbery, Nursery garden, Fruit tree, Pottings and other planting.



产品名称 Product Description	图片 Picture	货号 Item No.	规格 Size	每袋数量 Qty/Bag (Pc)	每箱数量 Qty/Ctn (Pc)	纸箱规格 Ctn Size (Cm)	毛重 G.W (Kg)
360° 可调式 涡流喷头 Adjustable Flow Sprayer		AS0180B	0-80L/h@1Bar	500	6500	54*35*28	18
360° 可调式 地插涡流喷头 Adjustable Flow Sprayer with Spiker		AS0180H	0-80L/h@1Bar 15cm Length	100	1200	54*35*28	9

技术参数 Technical Data :

AOD0170B / AOD0170H						
齿数 Click	工作压力 VS 流量 Working Preaature (Bar) VS Discharge(L/h)					
	0.5Bar	1.0Bar	1.5Bar	2.0Bar	2.5Bar	3.0Bar
2	8	11	13	16	18	20
4	12	18	27	31	35	39
8	16	25	32	38	44	49
12	23	66	44	52	60	68
16	30	46	55	65	72	80
20	33	48	62	73	81	89
24	36	55	70	81	94	102
30	41	65	80	93	106	116
32	51	73	99	114	127	141
喷洒直径 Sprayer Diameter		0.1-1.6m / 0.1-1.9m				

*备注: 16 齿=1 圈 32 齿=2 圈,最大可调为 2 圈。
流量小于 12L/H 时滴水, 大于 12L/H 伞状出水。

* Note: 16click=1Turn 32click=2Turn Max Adjusting 2Turn.

Drip out when the flowing is less than 12L/h, Spary out when the flowing is more than 12L/h.

AS0180B / AS0180H						
齿数 Click	工作压力 VS 流量 Working Preaature (Bar) VS Discharge(L/h)					
	0.5Bar	1.0Bar	1.5Bar	2.0Bar	2.5Bar	3.0Bar
2	5	7	10	13	15	17
4	14	22	25	30	39	41
8	22	38	50	59	71	77
12	31	48	63	74	84	91
16	38	58	71	84	94	126
20	41	63	77	90	103	112
24	42	65	85	99	110	125
30	51	75	93	106	122	134
32	50	81	93	106	122	133
喷洒直径 Sprayer Diameter		0.1-2.2m / 0.1-2.8m				

*备注: 16 齿=1 圈 32 齿=2 圈,最大可调为 2 圈。
流量小于 14L/H 时滴水, 大于 14L/H 涡轮状喷洒。

* Note: 16click=1Turn 32click=2Turn Max Adjusting 2Turn.

Drip out when the flowing is less than 14L/h, Spary out when the flowing is more than 14L/h.

360° 压力补偿式涌泉喷头 PC Bubbler

特点 Features:

- 压力补偿式，在一定压力范围内流量保持稳定，无需再人工调整节量。
- 内置宽大流道和出水口，不易堵塞，使用寿命长。
- 采用优质硅胶片，出水均匀，流量稳定。
- 滴头上盖可以打开，便于检查和清洗。
- A Pressure Compensating, fixed sprayer diameter bubbler, Gentle spraying with uniform flow for all bubblers on same supply tube.
- With big passageway and outlet, anti-clogging with long life.
- Fixed with good quality of Silicon diaphragm so the effluent is uniform and the flow is stable.
- With 20cm height spike and connected with Dn5/3mm tubing, which is easy to fix the position near the planing.
- Easy to remove the cover of Bubbler for inspection and cleaning.

应用范围 Application:



- 压力调节范围广 (1-4Bar)，可适用于地形起伏不平的灌溉区域。
- 有 35L/h 和 55L/h 二款流量选择，满足不同作物需求。
- 适用于果树，灌木丛，苗圃及其他景观作物。
- With large range of pressure compensation (1-4Bar), good at irrigation on uneven terrain.
- Two type of flowing available 35L/h and 55L/h to meet different demand.
- Suitable for fruit tree, shrubbery, Flower garden, Pottings and other landscape plantings.



技术参数 Technical Data:

压力 对应 流量和射程直径 Working Pressure VS Flowing and Spraying Diameter					
货号 Item No.	工作压力 Working Pressure	1.0Bar	2.0Bar	3.0Bar	4.0Bar
PCT0235 B/S/H/F	Discharge	36L/h	38L/h	37L/h	35L/h
	Spraying Diameter	1.0m	1.5m	1.4m	1.3m
PCT0255 B/S/H/F	Discharge	56L/h	59L/h	58L/h	54L/h
	Spraying Diameter	1.2m	2.2m	2.9m	2.5m

* 备注：离地 20cm，无风条件下测试 Note: Tested in breezeless, 20cm above the ground.

产品名称 Product Description	图片 Picture	货号 Item No.	规格 Size	每袋数量 Qty/Bag (Pc)	每箱数量 Qty/Ctn (Pc)	纸箱规格 Ctn Size (Cm)	毛重 G.W (Kg)
压力补偿式涌泉喷头 PC Bubbler		PCT0235B	35L/h, Blue Barb	500	6500	54*35*28	17
		PCT0255B	55L/h, Green Barb	500	6500	54*35*28	17
		PCT0235S	35L/h, Blue Dn6*7 Stand	500	3000	54*35*28	10
		PCT0255S	55L/h, Green Dn6*7 Stand	500	3000	54*35*28	10
		PCT0235H	35L/h, Blue 20cm Height Stake	100	1400	54*35*28	10
		PCT0255H	55L/h, Green 20cm Height Stake	100	1400	54*35*28	10
		PCT0235F	35L/h, Blue 20cm Height Stake	100	1400	54*35*28	10
		PCT0255F	55L/h, Green 20cm Height Stake	100	1400	54*35*28	10



360° 压力补偿式涡流喷头 Full Circle PC Sprayer

特点 Features:

- 压力补偿式，在一定压力范围内流量保持稳定，无需再人工调整节量。
- 内置宽大流道和出水口，不易堵塞，使用寿命长。
- 采用优质硅胶片，出水均匀，流量稳定。
- 滴头上盖可以打开，便于检查和清洗。
- 采用优质工程塑料，耐化学腐蚀，抗紫外线，抗老化。
- 其中 ASPC0155B 带倒刺旁通，可直接打孔安排在 Dn12-32PE 管上，易于安装维护。
- 其中 ASPC0155H 带地插，可以与 Dn5/3mmPVC(或 Dn6mmPE) 毛管联接，可任意定点地插在作物附近。
- A Pressure Compensating sprayer with full circle diameter bubbler, Gentle spraying with uniform flow for all bubblers on same supply tube.
- With big passageway and outlet, anti-clogging with long life.
- Fixed with good quality of Silicon diaphragm so the effluent is uniform and the flow is stable.
- Easy to remove the cover of Bubbler for inspection and cleaning.
- Produced by good quality of raw plastic material with Anti-corrosion, Anti-UV and Anti-aging.
- ASPC0155B can be inserted into Dn12-32mm PE pipe directly with its Barb offtake, Easy for installation.
- ASPC0155H can be connected with Dn5/3mm pvc (or Dn6mm PE) tubing and easy to stick near the planing with its spike.



应用范围 Application:

- 压力调节范围广 (1-4Bar)，过滤等级：80 目以上。
- 适用于果树，灌木丛，苗圃及其他景观作物，及地形起伏不平的灌溉区域。
- With large range of pressure compensation (1-4Bar), Filtration above 80mesh.
- Suitable for fruit tree, shrubbery, Flower garden, Pottings and other plantings on uneven terrain.

产品名称 Product Description	图片 Picture	货号 Item No.	规格 Size	每袋数量 Qty/Bag (Pc)	每箱数量 Qty/Ctn (Pc)	纸箱规格 Ctn Size (Cm)
压力补偿式涡流喷头 Full Circle PC Sprayer		ASPC0135B	35L/h, Barb	500	6000	54*35*28
		ASPC0155B	55L/h, Barb	500	6000	54*35*28
		ASPC0135S	35L/h	500	3000	54*35*28
		ASPC0155S	55L/h	500	3000	54*35*28
		ASPC0135H	35L/h, 20cm Height Stake	100	1000	54*35*28
		ASPC0155H	55L/h, 20cm Height Stake	100	1000	54*35*28
		ASPC0135F	35L/h, 20cm Height Stake	100	1000	54*35*28
		ASPC0155F	55L/h, 20cm Height Stake	100	1000	54*35*28

技术参数 Technical Data:

压力 对应 流量和射程直径 Working Pressure VS Flowing and Spraying Diameter					
货号 Item No.	工作压力 Working Pressure	1.0Bar	2.0Bar	3.0Bar	4.0Bar
ASPC0135B/S/H/F	Discharge	33L/h	34L/h	35L/h	34L/h
	Spraying Diameter	0.8m	1.0m	1.1m	1.1m
ASPC0155B/S/H/F	Discharge	50L/h	55L/h	54L/h	53L/h
	Spraying Diameter	1.4m	2.2m	2.0m	1.4m

*备注: 离地 15cm, 无风条件下测试 Note: Tested in breezeless, 15cm above the ground.



压力补偿微喷头 PC Microsprinkler

特点 Features:

- 压力补偿范围广，在 1.5-4.0bar 压力下保持恒定出水量和相同的喷洒范围。
- 优异的压力补偿调节机制，确保在不同地形和不平地均匀灌溉。
- 防虫式设计，小虫或蚂蚁不易进入喷嘴，避免堵塞。
- 采用优质工程塑料，抗 UV，耐候性好，耐腐蚀，经久耐用。
- 独特设计流道，抗堵能力强，使用寿命长。
- 结构牢固紧凑，同时也易于拆装，方便清洗。
- Unique regulation mechanism ensures uniform irrigation and fertigation on uneven ground.
- Insect-proof nozzle, small insect or ant can not get into it, avoid to be clogging.
- Produced by good quality of plastic material with Anti-corrosion, Anti-UV and Anti-aging.
- Special design of flowing passage, good for clogging resistance with long working life.
- Sturdy and solid structure, also Easy to dismantle and assemble, good for cleaning.
- Large range of pressure compensation ensures constant flow and wetting range between 1.5-4.0 bar pressure.



应用范围 Application:

- 工作压力范围：1.5-4.0bar 推荐过滤等级：大于等于 80 目。
- 适用于树下灌溉或蔬菜等大田作物灌溉。
- 有 35L/H, 55L/H 和 100L/H 三种流量选择，满足不同灌溉需求。
- 有倒刺接头，内承插，快速接头和 1/2" 外牙接头四种连接方式，满足不同安装需求。
- 双射程叶轮设计，叶轮带限流条时，喷洒范围小，适合小树苗，剪去叶轮上限流条后，射程变远，适合树木长大后灌溉。
- Working pressure: 1.5-4.0bar, Recommended filtration : Above 80 mesh.
- For optimal undertree irrigation, vegetable and other planting in field.
- Three type of flowing available, 35L/h, 55L/h and 100L/h to meet different watering requirement.
- Four type of inlet connector available, 4/7 barb, 7 female, quick thread and 1/2" male thread to meet different installation.
- The Swivel with diameter limiter for 2 stages of wetting range,
- 1st stage: with diameter limiter, for young trees with small wetting range.
- 2nd stage: when the tree grows, diameter limiter can be broken off, thus enabling extended irrigation diameter.



Top Bearing



Bridge



Pop-Up Swivel



Color-Code Nozzle



Regulating Disk



4/7 Barb



φ7 Female



Quick Thread



1/2" Thread

产品名称 Product Description	图片 Picture	货号 Item No.	规格 Size	每袋数量 Qty/Bag(Pc)	每箱数量 Qty/Ctn(Pc)	纸箱规格 Ctn Size(Cm)
压力补偿微喷头 PC Microsprinkler		MSPC0135B/F/T/Q	35L/h	100	800	54*35*28
		MSPC0155B/F/T/Q	55L/h	100	800	54*35*28
		MSPC01100B/F/T/Q	100L/h	100	800	54*35*28

*备注：B 代表倒刺接头，F 代表内承插，T 代表外牙接头，Q 代表快速接头。 Note: B stand for Bard, F stand for Female, T stand for male Thread, Q stand for Quick thread.

技术参数 Technical Data:

压力 VS 流量表 Pressure VS Flow Rate	工作压力 Working Pressure (Bar)	流量 Flow Rate (L/h)		
		MSPC0135B/F/T/Q	MSPC0155B/F/T/Q	MSPC01100B/F/T/Q
	1.5	38	49	85
	2.0	40	52	90
	3.0	42	55	98
	4.0	43	57	95

喷嘴颜色 Nozzle Color	规格 Size	喷洒直径 Spraying Diameter (m)	
		带限流条 (1st stage)	不带限流条 (2nd stage)
绿色 Green	35L/h	2.8	5.6
棕色 Brown	55L/h	3.4	7.0
红色 Red	100L/h	3.6	7.4

*备注：喷头离地面1米无风条件下测试。

Note: Tested under no wind conditions, one meter height above ground.



1st Stage



2nd Stage



旋转微喷头 Microsprinkler

产品名称 Product Description	图片 Picture	货号 Item No.	规格 Size	每袋数量 Qty/Bag (Pc)	每箱数量 Qty/Ctn (Pc)	纸箱规格 Ctn Size (Cm)	毛重 G.W (Kg)
倒挂式 360 度全圆微喷头 360° No Bridge Mini Sprinklers, Upside Down Type		MS8030-MS8080	Dn7	100	4500	54*35*28	19
地插式 360 度全圆微喷头 360° No Bridge Mini Sprinklers, Standing Type		MS8130-MS8180	Dn7	100	4500	54*35*28	19

技术参数 Technical Data:

压力 VS 流量和射程 Pressure VS Flowing Wetting Diameter												
工作压力 Working Pressure			1Bar		1.5Bar		2.0Bar		2.5Bar		3.0Bar	
货号 Item No.	叶轮 颜色 Impeller Color	喷嘴 颜色 Nozzle Color	流量 Discharge	射程直径 Standing Diameter	流量 Discharge	射程直径 Standing Diameter	流量 Discharge	射程直径 Standing Diameter	流量 Discharge	射程直径 Standing Diameter	流量 Discharge	射程直径 Standing Diameter
MS8030	蓝色 Blue	Green	28L/h	6.0m	32L/h	6.0m	34L/h	6.4m	38L/h	6.4m	41L/h	6.6m
MS8050		Blue	40L/h	6.0m	49L/h	6.4m	49L/h	6.4m	54L/h	6.4m	60L/h	6.6m
MS8060		Yellow	53L/h	6.4m	56L/h	6.4m	66L/h	6.4m	71L/h	6.4m	77L/h	7.0m
MS8080		Red	65L/h	6.4m	80L/h	6.4m	80L/h	6.4m	86L/h	7.0m	95L/h	7.0m
MS8130	绿色 Green	Green	28L/h	6.0m	32L/h	6.0m	34L/h	6.4m	38L/h	6.4m	41L/h	6.6m
MS8150		Blue	40L/h	6.0m	49L/h	6.4m	49L/h	6.4m	54L/h	6.4m	60L/h	6.6m
MS8160		Yellow	53L/h	6.4m	56L/h	6.4m	66L/h	6.4m	71L/h	6.4m	77L/h	7.0m
MS8180		Red	65L/h	6.4m	80L/h	6.4m	80L/h	6.4m	86L/h	7.0m	95L/h	7.0m

*备注：地插高地面垂直距离为1米，倒挂离地面垂直距离1米，无风条件下测试

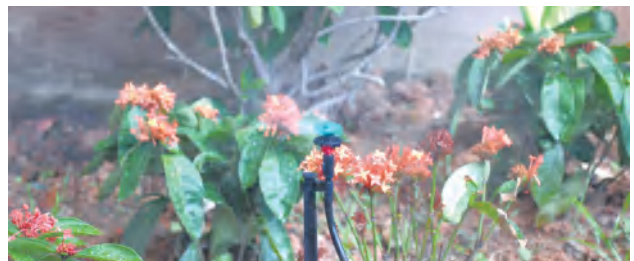













雾化喷头 Fogger

产品名称 Product Description	图片 Picture	货号 Item No.	规格 Size	每袋数量 Qty/Bag (Pc)	每箱数量 Qty/Ctn (Pc)	纸箱规格 Ctn Size (Cm)	毛重 G.W (Kg)
四出口雾化喷头 4 Outlet Fogger		MJ1301A	绿色喷嘴 Green Nozzle	100	1200	54*35*28	18
		MJ1301B	灰色喷嘴 Grey Nozzle	100	1200	54*35*28	18
四出口雾化喷头 4 Outlet Fogger		MJ1301	黑色喷嘴 Black Nozzle	100	2000	54*35*28	15
		MJ1302	灰色喷嘴 Grey Nozzle	100	2000	54*35*28	15
一出口雾化喷头 One Outlet Fogger		MJ1311	黑色喷嘴 Black Nozzle	100	10000	54*35*28	26
		MJ1312	灰色喷嘴 Grey Nozzle	100	10000	54*35*28	26

技术参数 Technical Data:

货号 Item No.	工作压力				
	Working Pressure	2.5Bar	3.0Bar	3.5Bar	4.0Bar
MJ1301A	流量 Discharge 倒挂直径 Hanged Diameter	26L/h 1.6-2.0m	28L/h	30L/h	31L/h
MJ1301B	流量 Discharge 倒挂直径 Hanged Diameter	32L/h 1.6-2.0m	35L/h	38L/h	40L/h
MJ1301	流量 Discharge 倒挂直径 Hanged Diameter	32L/h 1.8-2.2m	35L/h	39L/h	41L/h
MJ1302	流量 Discharge 倒挂直径 Hanged Diameter	24L/h 1.8-2.4m	27L/h	29L/h	32L/h
MJ1311	流量 Discharge 倒挂直径 Hanged Diameter	8.0L/h 0.5-0.6m	8.8L/h	9.5L/h	10.0L/h
MJ1312	流量 Discharge 倒挂直径 Hanged Diameter	6.0L/h 0.4-2.0m	6.7L/h	7.2L/h	7.7L/h

微喷头配件 Accessory for Microspray

产品名称 ProductDescription	图片 Picture	货号 Item No.	规格 Size	每袋数量 Qty/Bag(Pc)	每箱数量 Qty/Ctn(Pc)	纸箱规格 Ctn Size(Cm)	毛重 G.W(Kg)
一边承插一边 倒刺直接 One Barbed Adaptor		5141	Dn7	100	30000	54*35*28	21
双边倒刺式直接 Double Barbed Adapter		5142	Dn7	100	30000	54*35*28	21
内承插式单边倒刺直接 One Inside Barbed Adaptor		5145	Dn7	100	14000	54*35*28	21
双边内承插式接头 Double Inside Barbed Adaptor		5147	Dn7	100	14000	54*35*28	18
重锤 Weight Hammer		5321	6cm 长 6cm Length	10	600	42*28*21	16
管上式堵头 Repairing End Line		5205	Dn6	50	20000	42*28*21	13
外螺纹变接头 Reducong Connector with Male Threaded		5194	Dn7*1/2"	100	3500	54*35*28	18
外承插地插接头 Male Support Adaptor for Stake		5148B	Dn8*7	100	4000	42*28*21	9
内承插地插接头 Emale Support Adaptor for Stake		5149B	Dn8*7	100	4000	42*28*21	9
卡扣地插 Clip stake		CS0133	33cm 长 33cm Length	10	400	54*35*28	10
		CS0143	43cm 长 43cm Length	10	300	54*35*28	11
直立式地插 Straight Stake		SS0330	30cm 长 30cm Length	10	400	54*35*28	9
		SS0340	40cm 长 40cm Length	10	350	54*35*28	11
PVC 软管 PVC Soft Pipe		PV010474	Dn7 / 4mm 4Bar	500 m/roll	3rolls/bag	Dn45*60	29

微喷头配件 Accessory for Microspray

产品名称 Product Description	图片 Picture	货号 Item No.	规格 Size	每袋数量 Qty/Bag (Pc)	每箱数量 Qty/Ctn (Pc)	纸箱规格 Ctn Size (Cm)	毛重 G.W (Kg)
倒挂三件套 Microsprinkler Hanged Support Set		HMS01	50cm 长 50cm Length	10	400	54*35*28	19
防滴倒挂三件套 Microsprinkler Hanged Support Set with Anti- drainage Valve		HMS02	50cm 长 50cm Length	10	400	54*35*28	26
地插全套 地插微喷头 Microsprinkler Stake and Tubing		SMS0230	30cm 高 50cm 长 30cm Height 50cm Pipe	10	250	54*35*28	14
		SMS0240	40cm 高 50cm 长 40cm Height 50cm Pipe	10	200	54*35*28	12
内承插·内承插式 防滴器 Mini Anti-drainage Valve		4100	Dn7 Socket	100	6000	54*35*28	19
倒刺·内承插式防 滴器 Mini Anti-drainage Valve		4101	Dn7 Barb*Socket	100	6500	54*35*28	20
内承插·外承插式 防滴器 Mini Anti-drainage Valve		4102	Dn7 Female socket*Socket	100	6000	54*35*28	20
倒刺·外承插式防 滴器 Mini Anti-drainage Valve		4103	Dn7 Barb*Female Socket	100	6000	54*35*28	19

备注：· 防滴器可有效的控制倒挂微喷头配件在阀门关紧停水情况下，确保微喷头不滴水，从而有效保护作物。
 · 当系统压力高于 0.7-1.0bar 时，水量通过防滴器微喷头开始喷水。
 · 当系统压力低于 0.4-0.8bar 时，水量停止通过防滴器微喷头停止喷水。

Note: · The Mini Anti-drainage vale can prevent the water from leaking the ground and prevent the little planting when microsprinkler or microjet is handed.
 · When the pressure in system is up to 0.7-1.0bar, water flow through the Mini Anti-drainage valve.
 · When the pressure in system is less than 0.4bar-0.8bar, water would be prevented by mini anti-drainage valve.

T 自动反冲洗过滤系统 T Automatic Self-Clean Filtration System

- T 系列是由多个 T 型 2 寸或 3 寸叠片式自动反冲洗过滤器、2 寸或 3 寸反冲洗阀、控制器等组成的高度集成自动清洗过滤系统。系统安装简单，运行高效。适用于首部或二级自动过滤系统，可有效过滤水源中的各类悬浮杂质。
- 流量范围：40-180m³/h
- T series is a highly integrated self-cleaning filter system which is combined by several 2" or 3" automatic backflush self-cleaning disc filter, 2" or 3" backwash hydraulic valve, controller etc.. It could be installed easily and work efficiency. Suitable for head or secondary filtration system to filter the water containing various suspended contaminants.
- Flowing Rate: 40-180m³/h



特点 Features:

- 操作简单 - 控制系统为中 / 英文界面，设置简单易操作。
- 节省人力 - 可全自动反冲洗同时系统稳定可靠，无需人工频繁维护。
- 节水节能 - 低水压低流量反冲洗设计，减少水电损耗。
- 可靠耐用 - 采用优质工程塑料制造，耐化学腐蚀，抗 UV 耐老化。
- Easy Operation: The control system is the Chinese / English interface, with simple and easy to operate.
- Saving manual labour: Program setting automatic backwash, less manual maintenance requirement.
- Saving Water and Energy: Maximum filtration efficiency based on minimum backflushing pressure required.
- Reliable and durable: Produced by excellent raw material which is of corrosion, chemical and UV resistant.

技术参数 Technical Data:

- 最大工作压力 :10 Bar (145 Psi)
- 最小反冲洗压力 :1.3 Bar (18 Psi)
- 每单元最小反冲流量 :7m³/h (31 gpm)
- Maximum Pressure: 10 Bar (145 Psi)
- Minimum Backflushing Pressure: 1.3 Bar (18 Psi)
- Minimum Backflushing Flow Rate of each unit Filter: 7m³/h (31 gpm)

货号 Item No.	单元尺寸 Size of Filter	单元数量 Number of Filter	管道尺寸 Manifold Dia	最大流量 Max Flow		连接方式 Connection	控制单元 Control Unit
				m ³ /h	gpm		
T202-3	2"	2	3" (Dn80)	40	176	法兰 /Flange	12VDC Latch/10Unit
T203-3	2"	3	3"(Dn80)	60	264	法兰 /Flange	
T204-4	2"	4	4"(Dn100)	80	352	法兰 /Flange	
T302-4	3"	2	4"(Dn100)	60	264	法兰 /Flange	
T303-4	3"	3	4"(Dn100)	90	393	法兰 /Flange	
T304-6	3"	4	6"(Dn150)	120	524	法兰 /Flange	
T305-6	3"	5	6"(Dn150)	150	655	法兰 /Flange	
T306-6	3"	6	6"(Dn150)	180	786	法兰 /Flange	

工作原理 Technology:

- 过滤状态: 控制器控制反冲洗阀开关方向使过滤器进入过滤状态: 水流先后通过系统进水管、反冲洗阀、过滤器进水口进入过滤器, 水中杂质经叠片过滤后, 清水从过滤器出水口流到系统出水管。
- Filtration Process: The controller controls the direction of the backwash valve to make the filter enter the filtration stage: The source water enters the filter passing through the system inlet pipe, backwash valve, and filter inlet one after another. Then the dirt stopped by disc and clean water pass through filter outlet to system outlet pipe.
- 冲洗状态: 控制器检测到系统进、出水口压差大于设定值后控制反冲洗阀改变开关方向, 从而使该过滤器进入冲洗状态: 经其他过滤器过滤后的清水经系统出水管从该过滤器出水口进入并冲洗叠片后, 污水通过过滤器进水口、反冲洗阀, 排出到系统污水管。
- Backflush Process: After the controller detects that the pressure difference between the inlet and outlet is greater than setted value, it controls the backwash valve to change direction, so that the filter enters the flushing stage: The clean water filtered by other filters passes through the system outlet pipe to the filter outlet and flushing the discs, then the dirty water passes through the filter inlet, the backwash valve and discharged to the system sewage pipe.

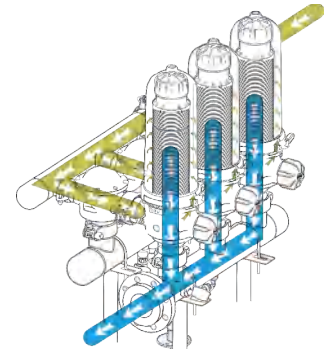

Filtration Process

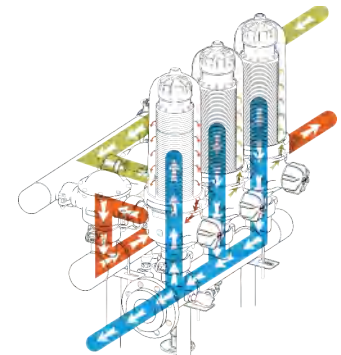

Backflush Process

尺寸 Dimension:

货号 Item No.	尺寸 Size (mm)								
	F	E	D	L	W	R	T	S	H
T202-3	272	204	715	698	700	255	495	277	915
T203-3	272	204	930	945	700	265	495	277	915
T204-4	272	204	1065	1220	700	290	515	287	935
T302-4	311	230	644	714	785	267	573	309	1162
T303-4	311	230	829	956	785	267	573	309	1162
T304-6	311	230	1065	1220	785	292	623	334	1212
T305-6	311	230	1419	1553	785	292	623	334	1212
T306-6	311	230	1694	1828	785	292	623	334	1212

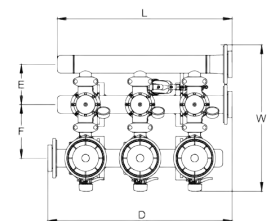
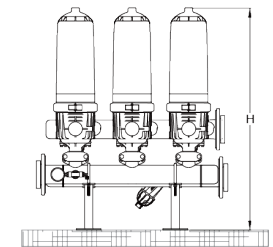
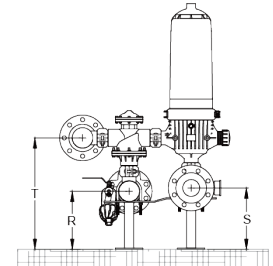

水头损失表 Head Loss Data:

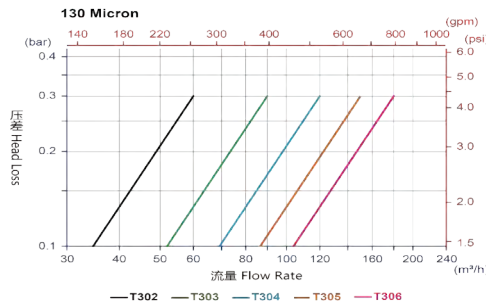
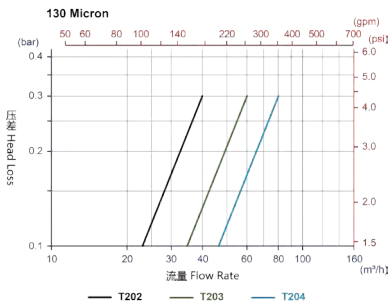

H 自动反冲洗过滤系统 H Automatic Self-Clean Filtration System

- H 系列是由 3 个以上 3" 或 4 寸 H 型叠片式自动反冲洗过滤器、3" 或 4" 寸反冲洗阀、控制器等组成的高度集成自动清洗过滤系统。系统安装简单，运行高效。
- 适用于首部或二级自动过滤系统，可有效过滤水源中的各类悬浮杂质。
流量范围：120-600 m³/h
- H series is a highly integrated self-cleaning filter system which is combined by several 3" or 4" automatic backflush self-cleaning disc filter, 3" or 4" backwash hydraulic valve, controller etc.. It could be installed easily and work efficiency. Suitable for head or secondary filtration system to filter the water containing various suspended contaminants.
- Flowing Rate: 120-600 m³/h



特点 Features:

- 操作简单 - 控制系统为中 / 英文界面，设置简单易操作。
- 节省人力 - 可全自动反冲洗同时系统稳定可靠，无需人工频繁维护。
- 节水节能 - 低水压低流量反冲洗设计，减少水电损耗。
- 可靠耐用 - 采用优质工程塑料制造，耐化学腐蚀，抗 UV 耐老化。
- Easy Operation: The control system is the Chinese / English interface, with simple and easy to operate.
- Saving manual labour: Program setting automatic backwash, less manual maintenance requirement.
- Saving Water and Energy: Maximum filtration efficiency based on minimum backflushing pressure required.
- Reliable and durable: Produced by excellent raw material which is of corrosion, chemical and UV resistant.

技术参数 Technical Data:

- 最大工作压力 :10 Bar (145 Psi)
- 最小反冲洗压力 :1.6 Bar (23 Psi)
- 每单元最小反冲洗流量 :18m³/h (80 gpm)
- Maximum Pressure: 10 Bar (145 Psi)
- Minimum Backflushing Pressure: 1.6 Bar (23 Psi)
- Minimum Backflushing Flow Rate of each unit Filter: 18m³/h (80 gpm)

货号 Item No.	单元尺寸 Size of Filter	单元数量 Number of Filter	管道尺寸 Manifold Dia	最大流量 Max Flow		连接方式 Connection	控制单元 Control Unit
				m ³ /h	gpm		
H303-6	3"	3	6" (Dn150)	120	524	法兰 /Flange	12VDC Latch/10Unit
H304-6	3"	4	6"(Dn150)	160	698	法兰 /Flange	
H305-6	3"	5	6"(Dn150)	200	874	法兰 /Flange	
H403-6	4"	3	6" (Dn150)	180	786	法兰 /Flange	
H404-6	4"	4	6"(Dn150)	240	1048	法兰 /Flange	
H405-6	4"	5	6"(Dn150)	300	1310	法兰 /Flange	
H406-8	4"	6	8"(Dn200)	360	1572	法兰 /Flange	
H407-8	4"	7	8"(Dn200)	420	1834	法兰 /Flange	
H408-8	4"	8	8"(Dn200)	480	2096	法兰 /Flange	
H409-10	4"	9	10"(Dn250)	540	2358	法兰 /Flange	
H410-10	4"	10	10"(Dn250)	600	2620	法兰 /Flange	

工作原理 Technology:

- 过滤状态: 控制器控制反冲洗阀开关方向使过滤器进入过滤状态: 水流先后通过系统进水管、反冲洗阀、过滤器进水口进入过滤器, 水中杂质经叠片过滤后, 清水从过滤器出水口流到系统出水管。
- Filtration Process: The controller controls the direction of the backwash valve to make the filter enter the filtration stage: The source water enters the filter passing through the system inlet pipe, backwash valve, and filter inlet one after another. Then the dirt is stopped by disc and clean water pass through filter outlet to system outlet pipe.
- 冲洗状态: 控制器检测到系统进、出水口压差大于设定值后控制反冲洗阀改变开关方向, 从而使该过滤器进入冲洗状态: 经其他过滤器过滤后的清水经系统出水管从该过滤器出水口进入并冲洗叠片后, 污水通过过滤器进水口、反冲洗阀, 排出到系统污水管。
- Backflush Process: After the controller detects that the pressure difference between the inlet and outlet is greater than setted value, it controls the backwash valve to change direction, so that the filter enters the flushing stage: The clean water filtered by other filters passes through the system outlet pipe to the filter outlet and flushing the discs, then the dirty water passes through the filter inlet, the backwash valve and discharged to the system sewage pipe.

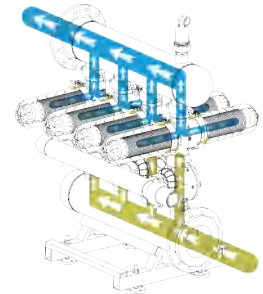

Filtration Process

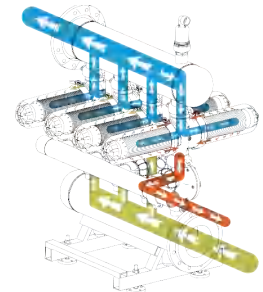

Backflush Process

货号 Item No.	尺寸 Size (mm)								
	F	E	D	L	W	R	T	S	H
H303-6	860	300	930	1040	975	565	300	1170	1670
H304-6	860	300	1145	1285	975	565	300	1170	1670
H305-6	860	300	1420	1560	975	565	300	1170	1670
H403-6	888	306	930	1040	1220	573	300	1188	1690
H404-6	888	306	1145	1285	1220	573	300	1188	1690
H405-6	888	306	1420	1560	1220	573	300	1188	1690
T406-8	928	306	1745	1850	1220	613	320	1248	1770
H407-8	928	306	2020	2125	1220	613	320	1248	1770
H408-8	928	306	2295	2400	1220	613	320	1248	1770
H409-10	978	306	2604	2695	1220	668	350	1328	1875
H410-10	978	306	3029	3120	1220	668	350	1328	1875

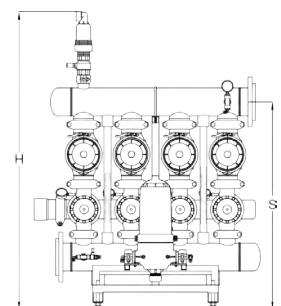
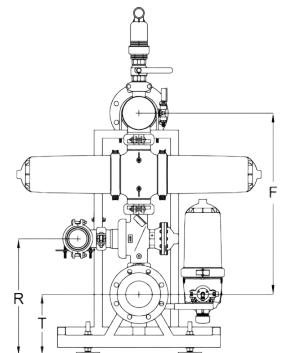
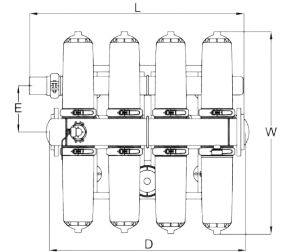

水头损失表 Head Loss Data:

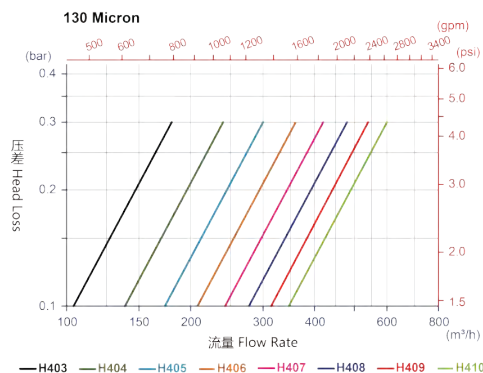
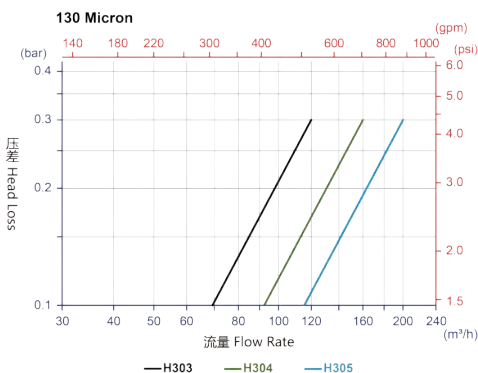

自动反冲洗叠片过滤器 Automatic Self-Cleaning Disc Filter

- 本系列过滤器为叠片式自动反冲洗过滤器，适用于首部或二级自动过滤系统，可有效过滤水源中的各类悬浮杂质。过滤性能稳定、高效，相比普通叠片过滤器，其具有反冲洗功能，大幅减少系统维护频率，节省人工，提高系统运行效率。
- This filter is automatic backflush self-cleaning disc filter, to be installed on head or secondary filtration system to filter the water containing various suspended contaminants. It is much more stable and efficient than manual disc filter by the auto back-wash which could reduce the maintenance frequency to save labor and improve the efficiency of system.



特点 Features:

- 节水节能 - 可低水压低流量反冲洗设计，减少水电损耗。
- 可靠耐用 - 采用优质工程塑料制造，耐化学腐蚀，抗 UV 耐老化。
- 高效过滤 - 过滤面积大，水头损失小；离心式进水设计，降低反冲洗频次。
- 低频维护 - 凹槽式反冲洗叠片，可实现表面过滤和深层过滤，自动反冲洗无需人工频繁维护。
- Highly Efficient Filtration: Less head loss and backflush frequency by large filtration area size and centrifugal water inlet.
- Saving Water and Energy: Maximum filtration efficiency based on minimum backflushing pressure required.
- Reliable and durable: Produced by excellent raw material which is of corrosion, chemical and UV resistant.
- Less Maintenance Effort: Less manual maintenance requirement, benefit from the enhanced and grooved autoflush disc which could be surface and depth filtration.

应用范围 Application:

- 农业灌溉系统的初级或者二次过滤系统。
- 工业循环用水的过滤系统。
- 污水处理的过滤系统。
- Primary or secondary filtration system for agriculture irrigation system.
- Filtration system for industrial circulating water.
- Filtration system for sewage treatment.

技术参数 Technical Data:

- 最高工作温度：60°C
- 连接方式：卡箍链接
- 最大工作压力：10 Bar (145 Psi)
- Maximum Working Temperature: 60°C
- End Connections: Grooved
- Maximum Pressure: 10 Bar (145 Psi)

尺寸 Size	单个过滤器最小反冲洗压力 Minimum Backflushing Pressure per Filter		单个过滤器最小反冲洗流量 Minimum Backflushing Flow Rate per Filter	
	Bar	Psi	m ³ /h	gpm
2"	1.3	18	7	31
3"	1.5	21	9	40
4"	1.6	23	18	80

产品名称 Product Description	图片 Picture	货号 Item No.	规格 Size	每箱数量 Carton Qty (Pc)
T 型自动反冲洗叠片过滤器 T Automatic Self-Cleaning Disc Filter		T2AD120V	120Mesh 2"Grooved	1
		T3AD120V	120Mesh 3"Grooved	1
H 型自动反冲洗叠片过滤器 H Automatic Self-Cleaning Disc Filter		H3AD120V	120Mesh 3"Grooved	1
		H4AD120V	120Mesh 4"Grooved	1

工作原理 Technology:

- 过滤状态: 滤芯上各叠片间被弹簧压紧, 水流从进水口进入再经过离心盘后产生离心效应, 使水中大颗粒重型杂质远离滤芯并集中于过滤器顶部, 其余微型杂质在跟随水流通过叠片滤芯缝隙时被阻挡达到过滤效果, 从而大大增加了过滤效率, 降低冲洗频次。
- Filtration Process: discs are compressed by a pre-loaded spring. The entering water passes through centrifugal structure, then being centrifugal effect flowing. The flowing enforce large contaminants away from discs. The water then passes efficiently through the discs thus small contaminants be trapped.
- 冲洗状态: 水流反方向进入过滤器并冲开弹簧, 滤芯上的各叠片互相散开, 反冲洗水流通过滤芯架的小孔喷射向叠片并带动叠片旋转和颤动, 最终使附着在叠片上的杂质被冲走并从过滤器的排污口排出。
- Backflush Process: water enters the filter from the opposite direction and discs are released after spring elevating. Water are then forced through the nozzles on the spine and jetting forward to discs. At this stage the discs spin freely, loosening the trapped solids which are then flushed out.



Filtration Process



Backflush Process

尺寸 Dimension:

		尺寸 (Size)					过滤面积 Filtering Surface		最大流量 Maximum Flow Rate					
		DN	Inch	W (mm)	D (mm)	H (mm)	cm ²	in ²	75mesh 200micron		120mesh 130micron		150mesh 100micron	
									m ³ /h	gpm	m ³ /h	gpm	m ³ /h	gpm
50	T 2"	309	220	595	1052	163	22	97	20	88	15	66		
80	T 3"	336	220	727	1492	231	32	139	30	131	20	88		
80	H 3"	336	220	975	2104	326	44	194	40	176	30	132		
100	H 4"	341	220	1200	2984	463	64	278	60	262	40	176		

标准过滤精度

Standard Filtration Grade:

	叠片颜色 Disc Color		过滤精度 Filtration Grade	
		绿色 Green	80mesh 200micron	
		红色 Red	120mesh 130micron	
		橙色 Orange	150mesh 100micron	

水头损失表 Head Loss Data:

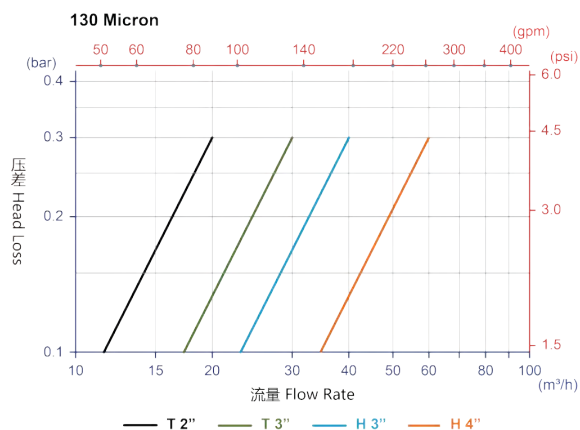

材质 Material:

部件 Parts	材质 Material
主体 Housing	尼龙加纤 PA+GF30%
叠片 Discs	聚丙烯 PP
卡箍 Clamp	不锈钢 Stainless Steel
密封圈 Sealing	橡胶 NBR

手动叠片过滤器 Manual Disc Filter

- 本系列过滤器为叠片式过滤器，适用于小型过滤系统，可有效过滤水源中的各类悬浮杂质。过滤性能稳定、可靠。
- This series disc filters suit for small filtration system to filter the water containing various suspended contaminants. It supply stable and reliable filtration.



特点 Features:

- 经久耐用 - 采用优质工程塑料制造，耐化学腐蚀，抗 UV 耐老化。
- 低频维护 - 凹槽式叠片，过滤面积大，降低清洗频次。
- 可靠性能 - 离心式进水让大颗粒杂质远离叠片，水头损失小，实现高效过滤。
- Highly Durable: Produced by excellent raw material which is of corrosion, chemical and UV resistant.
- Less Maintenance: Less washing frequency benefit from grooved disc with large filtration surface.
- Reliable Performance: Centrifugal inlet water force the particles away from discs, that guarantee the high efficiency filtration with less head loss.

应用范围 Application:

- 小型农业灌溉系统的初级或者二次过滤系统。
- 工业循环用水的过滤系统。
- 污水处理的过滤系统。
- Primary or secondary filtration system for small agriculture irrigation system.
- Filtration system for industrial circulating water.
- Filtration system for sewage treatment.

技术参数 Technical Data:

- 最高温度：60°C
- 连接方式：外螺纹 / 卡箍
- 最大工作压力：10 Bar (145 Psi)
- Maximum Temperature: 60°C
- End Connections: Male Threaded / Grooved
- Maximum Pressure: 10 Bar (145 Psi)

产品名称 Product Description	图片 Picture	货号 Item No.	规格 Size	每箱数量 Carton Qty (Pc)
T 型手动叠片过滤器 T Type Manual Disc Filter		T2MD120B/N	120Mesh 2"BSP/NPT	1
		T3MD120B/N	120Mesh 3"BSP/NPT	1
H 型手动叠片过滤器 H Type Manual Disc Filter		H3MD120B/N/V/F	120Mesh 3" BSP/ NPT/VIC/Flange	1
		H4MD120B/N/V/F	120Mesh 4" BSP/ NPT/VIC/Flange	1

工作原理 Technology:

- 过滤状态: 水流从进水口进入再经过离心盘后产生离心效应, 使水中大颗粒重型杂质远离滤芯并集中于过滤器顶部, 其余微型杂质在跟随水流通过叠片滤芯缝隙时被阻挡达到过滤效果, 从而大大增加了过滤效率, 降低冲洗频次。
- Filtration Process: The entering water passes throughs centrifugal structure, then being centrifugal effect flowing. The flowing enforce large contaminants away from discs. The water then passes efficiently through the discs thus small contaminants be trapped.



Filtration Process

尺寸 (Size)		过滤面积 Filtering Surface		最大流量 Maximum Flow Rate								
				75mesh 200micron		120mesh 130micron		150mesh 100micron				
				m ³ /h	gpm	m ³ /h	gpm	m ³ /h	gpm			
DN	Inch	W (mm)	D (mm)	H (mm)	cm ²	in ²						
50	T 2"	309	220	595	1198	186	34	150	30	132	26	114
80	T 3"	336	220	735	1699	263	56	247	50	220	38	167
80	H 3"	336	220	975	2396	371	69	304	60	264	51	225
100	H 4"	341	220	1200	3398	572	113	498	100	440	75	330

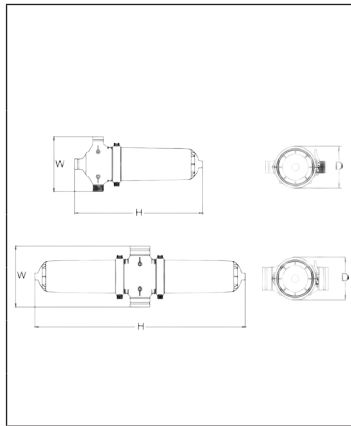

标准过滤精度 Standard Filtration Grade:

叠片颜色 Disc Color	过滤精度 Filtration Grade
绿色 Green	80mesh 200micron
红色 Red	120mesh 130micron
橙色 Orange	150mesh 100micron

水头损失表 Head Loss Data:

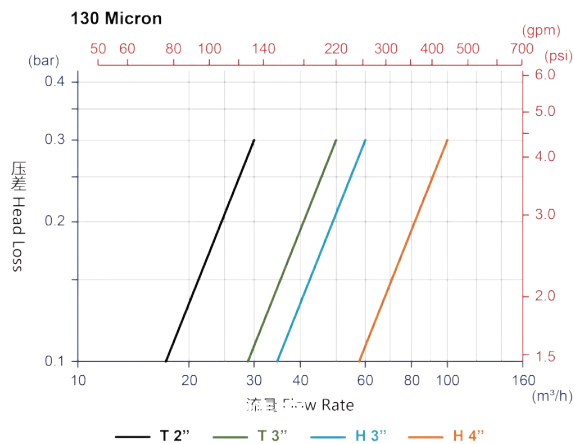

材质 Material:

部件 Parts	材质 Material
主体 Housing	聚丙烯加纤 PP+GF15%
叠片 Discs	聚丙烯 PP
卡箍 Clamp	不锈钢 Stainless Steel
密封圈 Sealing	橡胶 NBR



Y 型小型过滤器 Y Type Micro Filter

特点 Features:

- 外壳采用优质复合塑料生产，耐压、抗冲击、坚固耐用。
- 过滤内芯有不锈钢网和叠片两种可供选择，适应不同需要。
- 可过滤不同水质，广泛应用于农业和工业的水处理。
- 多种标准规格可供选择，满足不同需求。
- 易于安装和操作。
- Housings made of very strong plastic, designed to resist great pressure which can be used for long time.
- Two kind of filtration element, stainless screen and disc to be chosen to meet different requirement.
- Can treat different kinds of water source and apply for the water treatment both in Agriculture and Industry.
- Many sizes available can be met widely demands.
- Easy installation and operation.



技术参数 Technical Data:

货号 Item No.	螺纹 Size	滤芯 Filter Elements	过滤精度 Filtration Grade	过滤面积 Filtering Surface (cm ²)	最大压力 Max. Pressure (Bar)	最大流量 Max. Flow (m ³ /h)	尺寸 Dimension (mm)			
							A	B	C	D
1725S120MBT/NT	3/4" BSP/NPT		120 Mesh	95	8	5	125	159	140	82
1732S120MBT/NT	1" BSP/NPT		120 Mesh	95	8	5	134	159	144	82
Y50S120B/N	1-1/2" BSP/NPT		120 Mesh	488	8	20	261	268	280	145
Y63S120B/N	2" BSP/NPT		120 Mesh	488	8	25	268	268	280	145
YB63S120B/N	2" Super BSP/NPT		120 Mesh	802	8	32	301	327	338	171
1725D120MBT/NT	3/4" BSP/NPT		120 Mesh	150	8	4	125	159	140	82
1732D120MBT/NT	1" BSP/NPT		120 Mesh	150	8	4	134	159	144	82
Y50D120B/N	1-1/2" BSP/NPT		120 Mesh	568	8	20	261	268	280	145
Y63D120B/N	2" BSP/NPT		120 Mesh	568	8	25	268	268	280	145
YB63D120B/N	2" Super BSP/NPT		120 Mesh	884	8	32	301	327	338	171

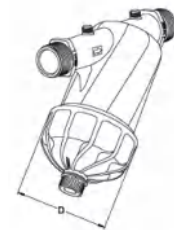
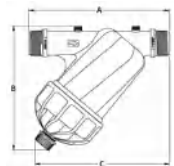

过滤器反冲洗阀 Filter Backwash Hydraulic Valve

- 本系列阀门为 T 型两位三通阀，是一款双腔结构的液压驱动隔膜式水力控制阀。
- 本阀门结构设计精良，水力驱动行程短，水流方向改变时平稳顺畅，运行稳定。
- 阀体双腔结构设计，入口水流方向有角式流向和直通流向，可适应各种场景过滤系统安装。
- This valve is T shape 3-way hydraulic valve with double chambered, hydraulically operated and diaphragm actuated which is suitable for various automatic backwashing of filtration systems.
- Benefit from excellent short hydraulic travel structure designed, It could change flow direction smooth.
- With two chambers structure, this valve is available in Angle flow (A) and Straight flow (S). It can be flexibly installed in multiple orientation to adapt various filter system.

特点 Features:

- 工作顺畅 - 水力驱动行程短，水流向切换顺畅，有效避免清水与污水混合。
- 可靠耐用 - 双腔结构，所需驱动压力低，有效延长隔膜寿命。
- 耐候性好 - 优质塑料制造，阀体抗腐蚀、耐老化。
- 安装方便 - 角式流向与直通流向两种水流方式适合不同安装场景。
- Double Chambered: low actuation pressure required, extend the lifetime of the diaphragm.
- Durable Performance: Produced by excellent engineered plastic which is of corrosion and UV resistant.
- Reliable Performance: change flow direction smoothly based on short travel hydraulic actuation design to avoid mixing of supply and waste water.
- Easy Installation: two flow direction modes, Angle flow (A) and Straight flow (S), to fit various automatic filtration system.



技术参数 Technical Data:

- 连接方式：卡箍链接
- 工作压力：0.7-10 Bar
- 最高使用温度：65°C
- 外压：工作压力的 85%-100%
- 控制腔工作容量：2" 为 0.13 升，3" 为 0.34 升，4" 为 0.55 升
- End Connections: Grooved
- Operating Pressure: 0.7-10 Bar
- Maximum Temperature: 65°C
- External Operating Pressure: 85%-100% of operating pressure
- Control Chamber Displacement Volume: 0.13L of 2", 0.34L of 3", 0.55L of 4"

应用范围 Application:

- 适用于各种自动反冲洗过滤器组：叠片过滤器，砂石过滤器，网式过滤器。
- Installing into multiple type automatic backwash filtration station: disk filters, sand filter, screen filters.

产品名称 Product Description	图片 Picture	货号 Item No.	连接口径 Connecting Dia	规格 Size	每箱数量 Ctn Qty (Pc)
过滤器反冲洗阀, 角式 Filter Backwash Hydraulic Valve, Angle Flow		BHV0150A	2" 卡箍 Grooved	角式 Angle	1
		BHV0180A	3" 卡箍 Grooved	角式 Angle	1
		BHV01100A	4" 卡箍 Grooved	角式 Angle	1
过滤器反冲洗阀, 直通式 Filter Backwash Hydraulic Valve, Straight Flow		BHV0150S	2" 卡箍 Grooved	直通式 Straight	1
		BHV0180S	3" 卡箍 Grooved	直通式 Straight	1
		BHV01100S	4" 卡箍 Grooved	直通式 Straight	1

尺寸 Dimension:

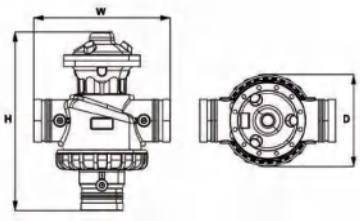
	尺寸 (Size)					阀门流量系数 Flow Rate of Valve							
	DN	Inch	W (mm)	D (mm)	H (mm)	角式流向 Angle Flow				直通式流向 Straight Flow			
						过滤 Filtration		反冲洗 Backwash		过滤 Filtration		反冲洗 Backwash	
						Kv	Cv	Kv	Cv	Kv	Cv	Kv	Cv
50	2"	232	160	274	52	60	48	56	46	53	60	70	
80	3"	287	192	378	110	127	100	115	93	107	122	141	
100	4"	357	260	464	225	260	205	237	190	220	250	290	

工作原理 Operation:

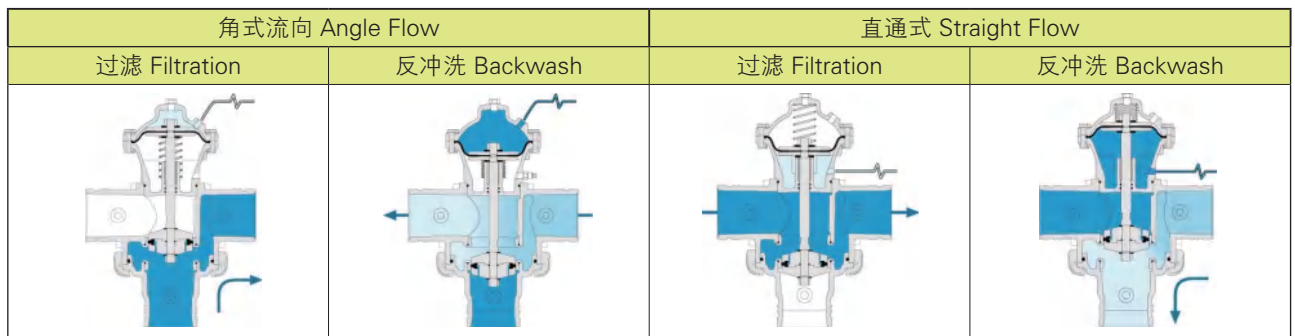

水头损失表 Head Loss Data:

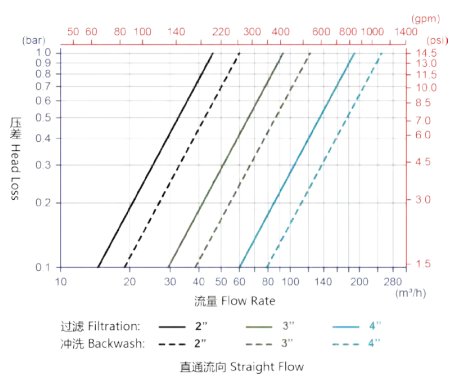
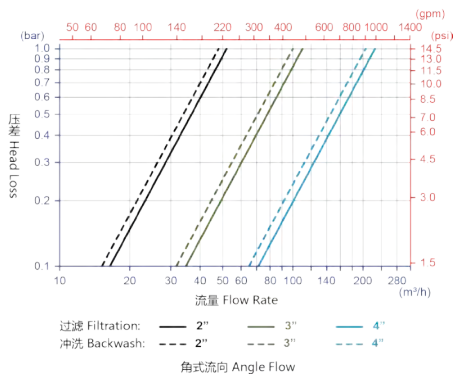

产品结构图 Part List:

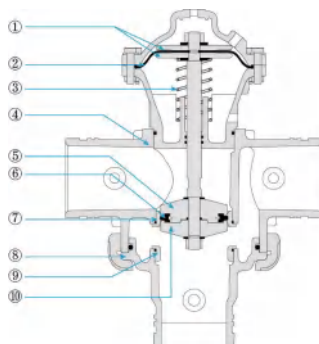

序号 Part	名称 Description
1	隔膜垫片 Diaphragm Washers
2	隔膜 Diaphragm
3	弹簧 Spring
4	阀体 Body
5	阀芯 Plug
6	O型圈 O-Ring
7	阀座 Seat
8	下部接头 Lower Adaptor
9	阀座 Seat
10	阀芯垫片 Plug Washer

自动过滤系统控制器 Controller for Automatic Self-Clean Filtration System

FC01 系列是专门为自动过滤系统设计的模块化反冲洗控制器，内置电脑微芯片和程序编辑，通过水压传感器（信息输入）和电磁阀（信息输出）将反冲阀、过滤单元、持压阀等零部件组成自动反冲洗过滤系统，可按照设定程序在线自动轮流清洗每个过滤单元，实现整个系统的过滤杂质自动清理，同时又不间断过滤供水，不影响正常灌溉作业。

FC01 is a modular controller, build-in programed microchip, designed for automatic backflush filtration system. It combines the backwash valves, filters, pressure sustaining valves etc. to be a automatic backflush filtration system through pressure sensor (input signal) and solenoid valve (output signal). It could control each filter unit to be flushed automatically by turns. Based on this, the filtration system achieves supplying continuously cleaned water to irrigation system while washing filter units in same time. So that irrigation system works nonstop.

特点 Features:

- 配有定制的液晶彩色显示屏，显示界面简洁人性化。
- 防水防潮设计，可适合不同工作环境。
- 10 个输出端口，可满足大部分系统过滤单元数量需求。
- 直流型自带 4 个 1# 电池 或 5V DC 电源适配器，安全可靠，防止雷击。
- Equipped with a customized color LCD display which user interface is simple and user-friendly.
- Chinese/English dual language, the program setting is simple and easy to operate.
- Suitable for different working environments benefit from waterproof and moisture-proof design.
- Can meet the number of filter units in most systems by 10 output ports.
- Power Supply is 4 pcs D battery or 5V DC power adapter, which are safe and reliable and prevent lightning strikes.



功能 Features:

- 可以设定三种反冲洗启动模式：定时启动、压差启动、手动启动；
- 可以灵活地设置反冲洗时长、反冲洗阀间隔时长、压差检测反应延迟时长；
- 可自动统计反冲洗次数，便于定期维护；
- 可自动检测并显示输出反冲洗阀站的数量；
- 电池电压不足时，屏上将显示低电压报警；
- 可一键恢复出厂时初始设置；
- 自带操作提示，无需复杂操作手册。
- It can be set three flushing mode: by time, by different pressure, by manual.
- It can be flexibly set the flushing time, flushing interval, DP response time etc.
- It can record flushing count automatically, which is convenient for regular maintenance.
- It can automatically detect and display the number of backwash valve stations.
- When the battery voltage is insufficient, a low voltage alarm will be displayed on the screen display.
- The factory default settings can be restored with one key.
- It comes with operation tips, no complicated operation manual is required.



技术参数 Technical Data:

- 显示屏：液晶彩屏 3.5"
- 输入电压：5-6VDC
- 输出电压：12VDC 脉冲
- 输入压差范围：0-2.0Bar
- 输出站点：10 个
- 防水等级：IP65
- 工作温度：0-60°C
- Display: 3.5" Colorful LCD
- Input Power: 5-6VDC
- Output Power: 12VDC Latching
- Input DP Range: 0-2.0 Bar (0-29 Psi)
- Output Port: 10 Stations
- Waterproof: IP65
- Working Temperature: 0-60°C

产品名称 Product Description	图片 Picture	货号 Item No.	规格 Size	每箱数量 Carton Qty (Pc)
自动过滤系统控制器 Automatic Filter System Controller		FC01DC10	12VDC / 10Unit	1

电磁头 (电机式) Solenoid Valve(Motor Type)

特点 Features:

- 能耗低, 可实现长距离控制。
- 三向流道底座, 可配置两位三通控制阀。
- 自带手动控制旋钮, 可选打开、关闭、自动三种模式。
- 大开孔流道设计, 控制阀响应速度快, 同时抗阻塞能力强。
- 本电磁头可与目前通用的控制器相配, 适用于各种灌溉自动控制系统。
- 分体式结构设计, 内置隔膜, 电机控制主体与过水流道分离, 使用寿命长。
- 内置电机式电磁头, 将电力信号转化为水力控制, 是控制阀门的重要组成部分。
- 有交 (直) 流电源和直流脉冲 3 种电源模式, 其中交 (直) 流两种电源模式合二为一。
- This Solenoid can be fitted with the common controllers for automatic irrigation system.
- Actuator motor designed for converting electric to hydraulic command which is essential part for Hydraulic controlling valve.
- Three version AC (DC) and DC Latching available, AC and DC version is 2 in 1.
- NC (Normally Closed) and NO (Normally Open) two modes available for selection.
- Designed with diaphragm inside which makes controlling main part separate from water passageways for long service life.
- Width water passageways designed for short reaction of controlling valve and anti-clogging.
- Manual controlling knob for CLOSE-AUTO-OPEN operation.
- 3-way hydraulic base can be fitting for the Hydraulic controlling with 3 position 2 way.
- Very low energy consumption for long distance control with long wire.



24VAC(DC)



12VDC Latching

技术参数 Technical Data:

- 工作压力: 0-10Bar
- 附带电线长度: 1 米
- 过滤等级: 至少 80 目
- 脉冲电磁头带红色和黑色种电线, 红色接正极, 黑色接负极
- 交 (直) 流型: 电压 24V(17-30V), 驱动电流 90mA, 维持电流 10mA
- 底座接口尺寸: 1/8" 内螺纹
- 最高环境温度: 60°C, 最高工作液体温度: 60°C
- 直流脉冲型: 电压 9-40V, 脉冲时间: 80-500 毫秒
- With 100cm Wires
- Filtration: Min. 80 mesh
- Pressure range: 0-10bar (0-140 psi)
- Hydraulic ports connecting: 1/8" BSP
- Max. fluid temperature: 60°C (140 °F)
- Max. ambient temperature: 60°C (140 °F)
- DC Latching version: Voltage 9-40V, Pulse width: 80-500ms
- AC (DC) version: Voltage 24V (17-30V), Current Inrush 90mA, Holding 10mA
- DC Latching version has red (positive) wire and black (negative) wire

推荐工况 (直流脉冲型) Recommended working condition (DC Pulse):

电压 (VDC) Voltage (VDC)	电容量 (uF) Capacitor (uF)	最少脉冲时间 (毫秒) Min. Pulse (ms)
12-18	4700	80
18-28	3300	80
28-40	2200	80

产品名称 Product Description	图片 Picture	货号 Item No.	规格 Size	每袋数量 Qty/Bag (Pc)	每箱数量 Qty/Ctn (Pc)	纸箱规格 Ctn Size (Cm)	毛重 G.W (Kg)
电磁头 (电机式), 24V 交 (直) 流, 带底座 Plus Solenoid Valve with Stand, 24VAC(DC)		EV0224S	24V	1	50	42*28*21	6
电磁头 (电机式), 12V 直流脉冲, 带底座 Plus Solenoid Valve with Stand, 12VDC Latching		EV0212S	12V	1	50	42*28*21	6

与主阀连接方式 How to Connect with Main Hydraulic Valve:

	水流方向 Flowing	
	常闭式 NC (Normally Closed)	常开式 NO (Normally Open)
断电 De-energized	 A: 进水 (pressure) B: 排水 (vent) C: 控制腔 (command)	 A: 排水 (vent) B: 进水 (pressure) C: 控制腔 (command)
通电 Energized	 A: 进水 (pressure) B: 排水 (vent) C: 控制腔 (command)	 A: 排水 (vent) B: 进水 (pressure) C: 控制腔 (command)

* 备注: 常闭式和常开式是指控制主阀类型。常闭式是指断电情况下阀门关闭, 常开式是指断电情况下阀门打开。
 * Note: NC & NO is referring to the Hydraulic valve.
 NC is hydraulic valve closing when de-energized, NO is hydraulic valve opening when de-energized.

不同型号电缆可连接控制器的最长距离 Maximum distance from controller to Solenoid Valve :

电缆规格 (AWG) Cable Gauge (AWG)	标称直径 (mm) Diameter (mm)	标称截面 (mm ²) Cross Section (mm ²)	AC 最长距离 (m) AC Max. Distance (m)	DC 最长距离 (m) DC Max.Distance (m)
24	0.5	0.2	600	—
20	0.8	0.5	1250	150
18	1.0	0.8	2000	—
17	1.1	1.0	2500	240
16	1.3	1.3	3500	—
15	1.4	1.5	5000	380

水力控制主阀 Plastic Hydraulic Control Main Valve

特点 Features:

- 控制阀有 Y 型、T 型两种阀体可选。
- 水力控制，操作简单，开关省力，维护方便。
- Y 型阀体设计，过流量大，水头损失小，反应灵敏。
- T 型阀体设计，外观简洁，体积小，容易安装，经济实用。
- 采用加固工程塑料生产，具有良好耐候性和机械性能，经久耐用。
- EPDM 柔性隔膜和导向阀芯完美组合，耐腐蚀，不变形，使用寿命长。
- 本款是隔膜式水力控制阀，由系统压力驱动，水力控制阀门开启或关闭。
- Hydraulic control valve with fixed inductive diaphragm inside, closed or opened by Hydraulic controlling.
- Two Type hydraulic control valve: Y Type and T Type.
- Y Type Designed, Big Channel and large discharge, small head lose, Response sensitivity and High precision for adjustment.
- T Type Designed with Simply surface, economical and practical, small and easy to install.
- EPDM Flexible inductive diaphragm and guide of valve core fixed well, corrosion resistance and no deformation.
- Easy to operate as hydraulic controlling, save effort to close or open and convenient maintenance.
- Produced by Reinforced plastic material with excellent hydraulic and mechanical function, use for long time.

技术参数 Technical Data:

- T 型规格: 3/4" (Dn20), 1" (Dn25), 1-1/2" (Dn40), 2" (Dn50).
- Y 型规格: 2" (Dn50), 2-1/2" (Dn65), 3" (Dn80), 4" (Dn100), 5" (Dn125), 6" (Dn150).
- 连接方式: 内牙 / 法兰 / 卡箍。
- 工作压力范围: 0.35-10bar (5-145psi)。
- 压力等级: 10Bar / 145Psi。
- 最高工作水温: 60°C。
- T Type Size: 3/4" (Dn20), 1" (Dn25), 1-1/2" (Dn40), 2" (Dn50) Connection.
- Y Type Size: 2" (Dn50), 2-1/2" (Dn65), 3" (Dn80), 4" (Dn100), 5" (Dn125), 6" (Dn150).
- Threaded / Flange / VIC.
- Working Pressure : 0.35-10bar (5-145psi).
- Max pressure: 10Bar / 145Psi.
- Highest working temperature: 60°C .

T 型阀门水头损失表
Head Lose Chart of T Type Valve

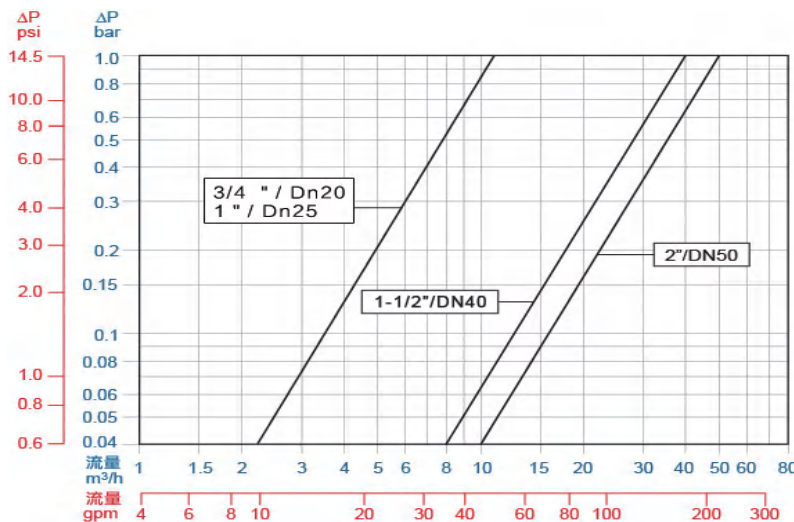

3/4" -2" (Dn20- Dn50)

阀门类型 Valve Type	阀门尺寸 Valve Size	阀门流量系数 Flow Rate of Valve	
		Kv m ³ /h@Δ1bar	Cv gpm@Δ1psi
T Type	3/4"	11	13
	1"	11	13
	1-1/2" (Dn40)	40	46
	2" (Dn50)	50	58

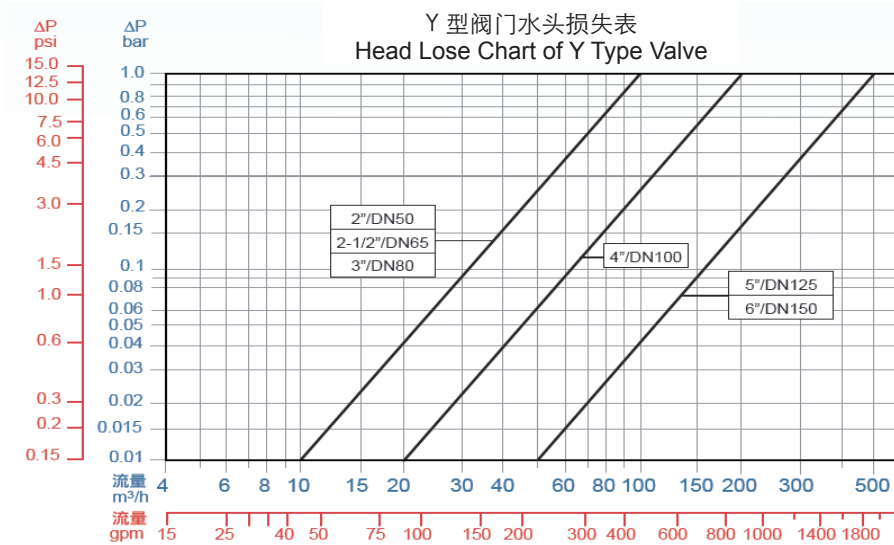

2"-6" (Dn50-DN150)

阀门类型 Valve Type	阀门尺寸 Valve Size	阀门流量系数 Flow Rate of Valve	
		Kv m ³ /h@Δ1bar	Cv gpm@Δ1psi
Y Type	2" (Dn50)	100	115
	2-1/2"(Dn65)	100	115
	3" (Dn80)	100	115
	4" (Dn100)	200	230
	5"(Dn125)	500	575
	6"(Dn150)	500	575

电磁开关阀 Solenoid Valve for On/Off Control

特点 Features:

- 开关稳定可靠, 安装维护简便。
- 三路二通控制方式, 开关启动压力低。
- 耐腐蚀, 密封性好, 可在恶劣环境下使用。
- 电磁头内置大孔径流道, 阀门开关响应速度快。
- 由电机式电磁头配上 T 型或 Y 型主阀, 电信号远程控制开启或关闭。
- Easy installation and maintenance.
- Installed with T or Y type main with solenoid for On/Off controlling.
- With big flowing inside, the response of valve for On/Off is quickly.
- With 3 way and 2 position controlling, the pressure for On/Off is low.
- Free from the influence of environment, On/Off is stable and reliable.

技术参数 Technical Data:

- 阀门类型: 常闭式。
- 连接方式: 内螺纹 / 法兰 / 卡箍。
- 主阀规格: 3/4" (Dn20), 1" (Dn25), 1-1/2" (Dn40), 2" (Dn50), 2-1/2" (Dn65), 3" (Dn80), 4" (Dn100), 5" (Dn125), 6" (Dn150)。
- Valve Type: Normal Closed (NC).
- Working Pressure: 0.4-10Bar.
- Connection: Female Thread / Flange / VIC Adaptor.
- Electric: 12VDC Latching / 24VAC (VDC).
- Valve Size: 3/4" (Dn20), 1" (Dn25), 1-1/2" (Dn40), 2" (Dn50), 2-1/2" (Dn65), 3" (Dn80), 4" (Dn100), 5" (Dn125), 6" (Dn150).
- 压力范围: 0.4-10Bar。
- 电源类型: 12V 直流脉冲 / 24V 交 (直) 流。

图片 Picture	货号 Item No.	规格 Size	包装 Packing
	E12HV0220B/N	3/4" BSP/NPT, 12VDC Latching	32Pc/Box
	E12HV0225B/N	1" BSP/NPT, 12VDC Latching	32Pc/Box
	E24HV0220B/N	3/4" BSP/NPT, 24VAC(DC)	32Pc/Box
	E24HV0225B/N	1" BSP/NPT, 24VAC (DC)	32Pc/Box
	E12HV0240B/N	1-1/2" BSP/NPT, 12VDC Latching	4Pc/Box
	E12HV0250B/N	2" BSP/NPT, 12VDC Latching	4Pc/Box
	E24HV0240B/N	1-1/2" BSP/NPT, 24VAC (DC)	4Pc/Box
	E24HV0250B/N	2" BSP/NPT, 24VAC (DC)	4Pc/Box
	E12HV0150B/N	2" BSP/NPT, 12VDC Latching	2Pc/Box
	E12HV0165B/N	2-1/2" BSP/NPT, 12VDC Latching	1Pc/Box
	E12HV0180B/N	3" BSP/NPT, 12VDC Latching	1Pc/Box
	E12HV0180F	3" Flange, 12VDC Latching	1Pc/Box
	E12HV01100F	4" Flange, 12VDC Latching	1Pc/Box
	E12HV01125F	5" Flange, 12VDC Latching	1Pc/Box
	E12HV01150F	6" Flange, 12VDC Latching	1Pc/Box
	E24HV0150B/N	2" BSP/NPT, 24VAC (DC)	2Pc/Box
	E24HV0165B/N	2-1/2" BSP/NPT, 24VAC (DC)	1Pc/Box
	E24HV0180B/N	3" BSP/NPT, 24VAC (DC)	1Pc/Box
	E24HV0180F	3" Flange, 24VAC (DC)	1Pc/Box
	E24HV01100F	4" Flange, 24VAC (DC)	1Pc/Box
	E24HV01125F	5" Flange, 24VAC(DC)	1Pc/Box
	E24HV01150F	6" Flange, 24VAC (DC)	1Pc/Box

减压阀 Pressure Reducing Valve



特点 Features:

- 压力调节精度高，减压稳压灵敏可靠。
- 减压阀由主阀、导阀、三向控制阀 / 电磁头组成水力控制调压系统。
- 利用导阀控制，能自动保持稳定出口压力，不需要其它装置和能源，使用简便。
- 适用安装在主管保护下游滴灌系统或微喷设备免受持续高水压的损坏，避免出现爆管。
- This valve is included Hydraulic valve, Pilot valve and 3-way control valve/ solenoid valve to be pressure reducing system.
- Controlled by Pilot valve and remain the outlet pressure stably without any other instruction or energy.
- Adjusting the pressure with high degree of accuracy, Reducing and sustaining pressure is sensible and reliable.
- Suitable to be installed in main line or sub line to avoid the following drip or mircosprinkler system to be damaged by high pressure.

技术参数 Technical Data:

- 规格: 1-1/2" (Dn40), 2" (Dn50), 2-1/2" (Dn65), 3" (Dn80), 4" (Dn100), 5" (Dn125), 6" (Dn150).
- Size: 1-1/2" (Dn40), 2" (Dn50), 2-1/2" (Dn65), 3" (Dn80), 4" (Dn100), 5" (Dn125), 6" (Dn150).
- 连接方式: 内螺纹 / 法兰 / 卡箍。
- Connection: Threaded / Flange / VIC.
- 工作压力范围: 0.35-10bar (5-145psi).
- Working Pressure : 0.35-10bar (5-145psi).
- 压力调节范围: 0.8-6.5bar (11-95psi).
- Pressure Adjusting Range: 0.8-6.5bar (11-95psi).

减压阀 (带手动三向阀) Pressure Reducing Valve (With Manual Three-way Valve)

图片 Picture	货号 Item No.	规格 Size	包装 Packing
	MHV0150B/N	2" BSP/NPT	1Pc/Box
	MHV0165B/N	2-1/2" BSP/NPT	1Pc/Box
	MHV0180B/N	3" BSP/NPT	1Pc/Box
	MHV0180F	3" Flange	1Pc/Box
	MHV01100F	4" Flange	1Pc/Box
	MHV01125F	5" Flange	1Pc/Box
	MHV0240B/N	1-1/2" BSP/NPT	2Pc/Box
	MHV0250B/N	2" BSP/NPT	2Pc/Box

减压阀 (带电磁头) Pressure Reducing Valve (with Solenoid Valve)

图片 Picture	货号 Item No.	规格 Size	包装 Packing
	E12MHV0150B/N	2" BSP/NPT, 12VDC Latching	1Pc/Box
	E12MHV0165B/N	2-1/2" BSP/NPT, 12VDC Latching	1Pc/Box
	E12MHV0180B/N	3" BSP/NPT, 12VDC Latching	1Pc/Box
	E12MHV0180F	3" Flange, 12VDC Latching	1Pc/Box
	E12MHV01100F	4" Flange, 12VDC Latching	1Pc/Box
	E12MHV01125F	5" Flange, 12VDC Latching	1Pc/Box
	E12MHV01150F	6" Flange, 12VDC Latching	1Pc/Box
	E24MHV0150B/N	2" BSP/NPT, 24VAC(DC)	1Pc/Box
	E24MHV0165B/N	2-1/2" BSP/NPT, 24VAC(DC)	1Pc/Box
	E24MHV0180B/N	3" BSP/NPT, 24VAC(DC)	1Pc/Box
	E24MHV0180F	3" Flange, 24VAC(DC)	1Pc/Box
	E24MHV01100F	4" Flange, 24VAC(DC)	1Pc/Box
	E24MHV01125F	5" Flange, 24VAC(DC)	1Pc/Box
	E24MHV01150F	6" Flange, 24VAC(DC)	1Pc/Box
	E12MHV0240B/N	1-1/2" BSP/NPT, 12VDC Latching	1Pc/Box
	E12MHV0250B/N	2" BSP/NPT, 12VDC Latching	1Pc/Box
	E24MHV0240B/N	1-1/2" BSP/NPT, 24VAC (DC)	1Pc/Box
	E24MHV0250B/N	2" BSP/NPT, 24VAC(DC)	1Pc/Box

水力控制阀其他应用 Other Hydraulic Control Valve



SHV0150B/N
SHV0180B/N/F
SHV01100F

持压阀 Pressure Sustaining Valve:

- 连接方式: 内螺纹 / 法兰 / 卡箍。
- 压力调节范围: 0.8-6.5bar (11-95psi).
- 规格: 1-1/2" (Dn40), 2" (Dn50), 2-1/2" (Dn65), 3" (Dn80), 4" (Dn100), 5" (Dn125), 6" (Dn150).
- 由主阀、导阀和三向控制阀组成水力控制持压系统, 常安装于自动过滤器系统后端, 当过滤器进行反冲洗时主阀部分关闭, 让前端过滤系统有足够的压力进行反冲洗。
- Connection: Threaded / Flange / VIC.
- Pressure Adjusting Range: 0.8-6.5bar (11-95psi).
- Size: 1-1/2" (Dn40), 2" (Dn50), 2-1/2" (Dn65), 3" (Dn80), 4" (Dn100), 5" (Dn125), 6" (Dn150).
- Installed with main valve, pilot and 3-way control valve to be pressure sustaining system. Remaining the above filter system to have enough pressure to flush when the filter system is in self-cleaning.



RHV0150B/N
RHV0180B/N/F
RHV01100F

快速泄压阀 Pressure Relief Valve:

- 压力调节范围: 1.0-10bar
- 连接方式: 内螺纹 / 法兰 / 卡箍。
- 规格: 1-1/2" (Dn40), 2" (Dn50), 2-1/2" (Dn65), 3" (Dn80), 4" (Dn100), 5" (Dn125), 6" (Dn150).
- 由主阀和泄压导阀组成管路保护系统。安装在水泵或减压阀后, 当压力大于设定值时, 该阀能迅速打开, 排除过高压, 避免爆管。
- Connection: Threaded / Flange / VIC.
- Pressure Adjusting Range: 1.0-10bar (15-155psi).
- Size: 1-1/2" (Dn40), 2" (Dn50), 2-1/2" (Dn65), 3" (Dn80), 4" (Dn100), 5" (Dn125), 6" (Dn150).
- Installed with main valve, pressure relief pilot and 3-way control valve to be pressure relief system. Fixed after pump set or pressure reducing valve, and open immediately release the pressure when pressure in system is too high.

控制阀配件 Accessories for Hydraulic Valve

图片 Picture	货号 Item No.	规格 Size
	PC200865	减压 / 持压导阀 Pressure Reducing/Sustaining Pilot 0.8-6.5Bar
	SX0130	三向控制阀 Three Way Control Valve
	FL0180	3" 法兰套件 3" Flange Set
	FL01100	4" 法兰套件 4" Flange Set
	FL01125	5" 法兰套件 5" Flange Set
	FL01150	6" 法兰套件 6" Flange Set
	VC0180	3" 卡箍接头 3" VIC Adaptor
	VC01100	4" 卡箍接头 4" VIC Adaptor
	KK0390	UPVC 管卡箍接头 VIC Adaptor for PVC Pipe, 90mm * 3" VIC
	KK04100	UPVC 管卡箍接头 VIC Adaptor for PVC Pipe, 110mm * 4" VIC
	ECA900203	UPVC 弯头带空气阀旁通 UPVC Elbow with Offtake for Air Valve 90mm * 2" BSP * 3" VIC
	ECA1100204	UPVC 弯头带空气阀旁通 UPVC Elbow with Offtake for Air Valve 110mm * 2" BSP * 4" VIC



C 型组合式空气阀 C Type Combination Air Valve

C 型是一款高品质组合式空气阀，适用于各种灌溉系统应用场合和工况。具有快速进排气口和自动微量排气口，因此在系统注水时，空气阀能快速排出管道中大量空气；在系统有压状态下，空气阀能持续排出管道中少量空气；在系统排空时，空气阀能吸入大量空气，防止形成负压。

C Type is a high quality combination air valve for a variety of irrigation networks and operating conditions. With its advanced aerodynamic design, double orifice and Surge, it allows efficient release of air pockets from system during pipelines filling, also release a little air continuously during pipeline pressurised and enables large volume air intake to avoid the vacuum formation in the event of network draining.

特点 Features:

- 进排气量大 - 采用先进的气体动力学设计，直流道阀体，排气口尺寸大，进排气量比传统空气阀大。
- 密封性好 - 密封工作压力低 (0.2bar/3.0psi)，防止滴漏现象。
- 喷射现象少 - 优异进排气通道结构，减少自动微量排气过程中喷射现象。
- 抗堵性好 - 进排气口带反冲洗结构，不易堆积泥垢，抗堵塞，能适合应用不同水质水源。
- 可靠耐用 - 主体采用优质工程塑料制造，耐化学腐蚀，抗 UV 耐老化；维护频率低，使用寿命长。
- Large Flow: Straight flow body with large diameter automatic orifice, more than usual flow rates.
- Excellent Seal: Prevents leakage under low pressure (0.2bar/3.0psi) by dynamic sealing.
- Less jetting: Reduces jetting water during automatic air release as the excellent intake and exhaust channel structure.
- Anti-clogging: The outlet with backwash structure is not easy to accumulate dirt, which can be suitable for different water quality.
- Reliable and durable: Produced by excellent raw material which is of corrosion, chemical and fertilizer resistant, less maintenance and longer service life.

应用 Application:

- 灌溉系统管网：排出灌溉系统中空气，防止水泵下游、主管沿线和主要分支管路在海拔高地方的空气积聚和真空负压形成。
- 灌溉控制首部：防止过滤器，施肥器和主控制阀下游的空气积聚和真空负压形成。
- 田间系统：防止靠近水表和调压阀的地方空气积聚和真空负压形成。
- 安装在泵站：最大限度地提高水泵工作效率及启动能力，并减少停电模式下水压的波动。
- Main Irrigation Networks: Protection against air accumulation and vacuum formation downstream of pumps, along supply lines and at high place in main irrigation networks.
- Irrigation Control Heads: Protection against air accumulation and vacuum formation at filtration, and fertilization stations and downstream of main control valves.
- Infield Systems: Protection against air accumulation and vacuum formation near water meters and automatic regulators.
- Pumping stations: Maximising pumping efficiency, priming capabilities and reducing the possibility of pressure surges during power stop.

产品名称 Product Description	图片 Picture	货号 Item No.	规格 Size	每袋数量 Qty/Bag (Pc)	每箱数量 Qty/Ctn (Pc)	纸箱规格 Ctn Size (Cm)
C 型组合式空气阀 C Type Combination Air Valve		CAV0125B/N	1"BSP/NPT	1	60	54*35*28
		CAV0150B/N	2"BSP/NPT	1	12	54*35*28

技术参数 Technical Data:

- 接口规格: 1"BSP/NPT (Dn25), 外螺纹
2"BSP/NPT (Dn50), 外螺纹
- 工作压力: 0.2-10Bar (3-150psi)
- 爆破压力: 35Bar (500psi)
- 使用温度: 1-60°C
- 主体材料: 加强尼龙
- 密封材料: EPDM
- Size : 1"BSP/NPT (Dn25) , Male Thread
2"BSP/NPT (Dn50) , Male Thread
- Working Pressure : 0.2-10Bar (3-150psi)
- Burst Pressure: 35Bar (500psi)
- Working Temperature : 1-60°C
- Body Material : Glass Reinforced Nylon
- Seal Material : EPDM

	尺寸 (Size)				重量 N.W.(kg)	排气口规格 Air Orifice Size (mm ²)	
	DN	Inch	D(mm)	H(mm)		动力式快速进排气口 Kinetic Orifice	微量排气口 Automatic Orifice
	25	1"	100	165	0.5	320	5.4
50	2"	198	248	1.4	1590	12.2	

产品结构图 Part List:

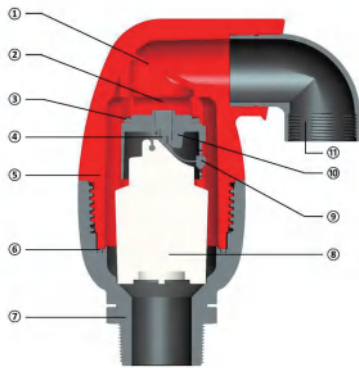

序号 Part	名称	Description
1	防虫网	Insect Screen
2	动力式快速进排气口	Kinetic Orifice
3	低压密封	Dynamic Seal
4	微量排气口	Automatic Orifice
5	阀体	Body
6	O 型圈	O-Ring
7	外螺纹底座	Male Threaded
8	浮球	Float
9	卷链式密封	Peel Seal
10	浮球罩	Kinetic Plug
11	排水弯头	Drainage Elbow

进排气流量性能表 Air Flow Performance Charts:

进排气 (系统注水、排空、负压工况)
Air Relief and Intake (Pipeline Filling,
Draining and Vacuum Conditions)

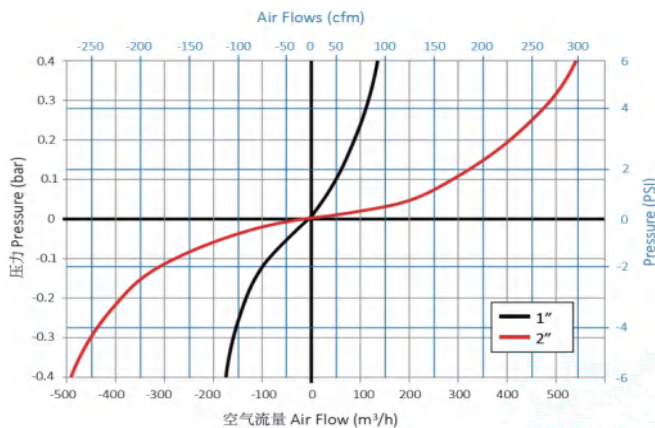

排气 (有压工况)
Air Release (Pressurized Operation)

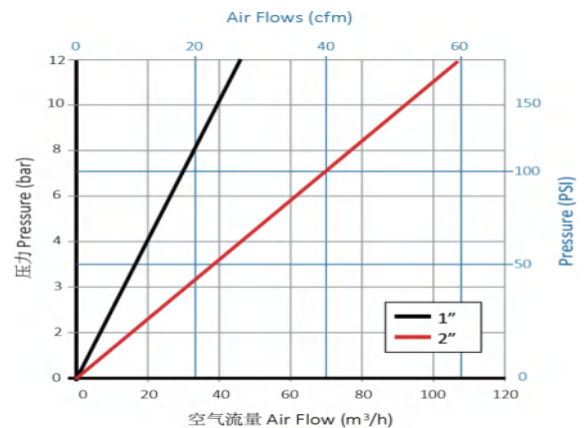

K 型快速进排气阀 K Type Kinetic Air Valve

K 型是一款动力式快速进排气阀，适用于各种灌溉系统应用场合和工况。本阀门采用符合气体动力学的先进设计，具有优异的快速进排气口，当系统注水时，空气阀能快速排出管道中大量空气，避免空气聚集在系统管道内；在系统排空时，空气阀能吸入大量空气，防止系统管道形成真空负压；同时低压时具有良好的密封性。

K Type is a high quality Kinetic Air Valve for a variety of irrigation networks and operating conditions. With its advanced aerodynamic design, this valve can evacuate large volume air during pipeline filling; enables large volume air intake and provides excellent protection against vacuum formation in the event of network draining. It is also with improved sealing under low pressure conditions.

特点 Features:

- 进排气量大 - 采用先进直流通道设计，进排气口尺寸大，进排气量比普通空气阀大。
- 进排气性能好 - 采用整体浮球防吹起设计，避免浮球过早封闭进出排气口，让阀能及时有效地吸入和排出空气。
- 密封性好 - 可在低压力下 (0.1bar/1.5psi) 保持良好的密封性，避免发生漏失现象。
- 性能可靠 - 结构简洁，符合气体动力学，运行可靠，维护频率低。
- 经久耐用 - 主体采用优质工程塑料制造，耐化学腐蚀，抗 UV 耐老化，使用寿命长。
- Large Flow: Straight flow body with large diameter automatic orifice: More than usual flow rates.
- Good intake and exhaust performance: With aerodynamic full-body kinetic shield, it prevents premature closing without disturbing air intake or discharge.
- Excellent Seal: Prevents leakage under low pressure (0.1bar /1.5psi) by dynamic sealing Compact, simple and reliable structure.
- Reliable and durable: Compact, simple and reliable structure whose parts are fully corrosion, chemical and fertilizer resistant Lower maintenance and increased life span.

应用 Application:

- 灌溉系统管网：排出灌溉系统中空气，防止水泵下游、沿程输水管道以及管道上下坡位置形成负压。
- 灌溉控制首部：防止过滤器，施肥器处形成负压。
- 田间系统：避免形成负压。
- Main Irrigation Networks: Air relief and vacuum prevention downstream of pumps, along supply lines and at elevations in main irrigation networks.
- Irrigation Control Heads: Air relief and vacuum prevention at filtration and fertilization stations.
- Infield Systems: Prevention of vacuum formation.

产品名称 Product Description	图片 Picture	货号 Item No.	规格 Size	每袋数量 Qty/Bag (Pc)	每箱数量 Qty/Ctn (Pc)	纸箱规格 Ctn Size (Cm)
K 型快速进排气阀 K Type Kinetic Air Valve		KAV0125B/N	1"BSP/NPT	1	70	54*35*28
		KAV0150B/N	2"BSP/NPT	1	36	54*35*28

技术参数 Technical Data:

- 接口规格: 1"BSP/NPT (Dn25), 外螺纹
2"BSP/NPT (Dn50), 内螺纹
- 工作压力: 0.1-10Bar (1.5-150psi)
- 爆破压力: 35Bar (500psi)
- 使用温度: 1-60°C
- 主体材料: 加强尼龙
- 密封材料: EPDM
- Size : 1"BSP/NPT (Dn25), Male Thread
2"BSP/NPT (Dn50), Female Thread
- Working Pressure : 0.1-10Bar (1.5-150psi)
- Burst Pressure: 35Bar (500psi)
- Working Temperature : 1-60°C
- Body Material : Glass Reinforced Nylon
- Seal Material : EPDM

		尺寸 (Size)				重量	动力式快速进排气口规格
		DN	Inch	D (mm)	H (mm)	N.W. (kg)	Kinetic Orifice Size (mm ²)
		25	1"	65	105	0.2	320
		50	2"	90	130	0.3	755

产品结构图 Part List:

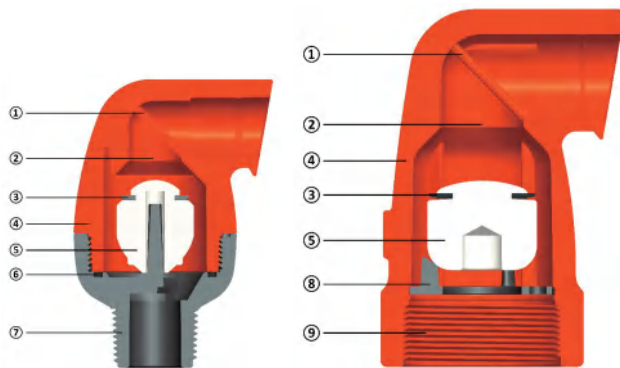

序号 Part	名称	Description
1	防虫网	Insect Screen
2	进排气口	Kinetic Orifice
3	低压密封	Dynamic Seal
4	阀体	Body
5	浮球	Float
6	O 型圈	O-Ring
7	外螺纹底座	Male Threaded
8	支架	Stopping Disc
9	内螺纹	Female Threaded

进排气流量性能表 Air Flow Performance Charts:

进排气 (系统注水、排空、负压工况)
Air Relief and Intake (Pipeline Filling, Draining and Vacuum Conditions)

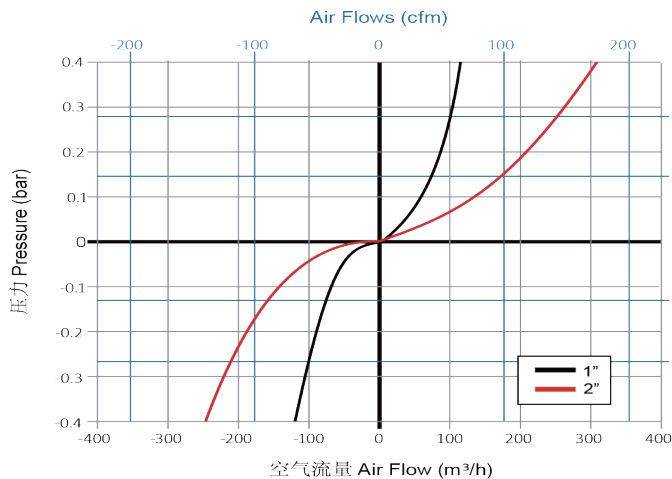

G 型快速进排气阀 G Type Kinetic Air Valve

G 型是一款高性价比动力式快速进排气阀，可以高效排出或者吸入空气。适用于管道系统、过滤系统及其他灌溉系统工况。当系统注水时，空气阀能快速排出管道中大量空气；在系统排空时，空气阀能吸入大量空气，防止系统管道被真空负压破坏。

G Type is a high cost-effective Kinetic Air Valve which is designed for efficient discharge and intake of air in pipeline systems, filter systems and other locations where confined air could impair the irrigation system's operation. It releases the air at high flow velocity during the initial filling of the system. And intaking large quantities of air to prevent pipelines away from collapse and cavitation damaged when pipe drains.

特点 Features:

- 进排气量大 - 大尺寸进排气口为灌溉系统提供最大限度的保护。
- 性能可靠 - 浮球防吹起设计，避免阀门过早关闭。
- 密封性好 - 在低压力下依然保持良好的密封性，避免漏水。
- 经久耐用 - 主体采用优质复合塑料制造，耐化学腐蚀，抗 UV 耐老化，使用寿命长。
- Large Flow: Provide maximum protection of irrigation system by large diameter orifice.
- Reliable performance: The valve remains open until water reaches the float.
- Great Sealing: Offers leak-proof sealing even at a low system pressure.
- Reliable and durable: Lower maintenance and increased life span by made of composite materials with corrosion and UV resistant.

应用 Application:

- 灌溉系统管网：排出灌溉系统中空气，防止水泵下游、沿程输水管道以及管道上下坡位置形成负压。
- 灌溉控制首部：防止过滤器，施肥器处形成负压。
- 田间系统：避免形成负压。
- Main Irrigation Networks: Air relief and vacuum prevention downstream of pumps, along supply lines and at elevations in main irrigation networks.
- Irrigation Control Heads: Air relief and vacuum prevention at filtration and fertilization stations.
- Infield Systems: Provention of vacuum formation.

产品名称 Product Description	图片 Picture	货号 Item No.	规格 Size	每袋数量 Qty/Bag (Pc)	每箱数量 Qty/Ctn (Pc)	纸箱规格 Ctn Size (Cm)
G 型快速进排气阀 G Type Kinetic Air Valve		KAV0320B/N	3/4"BSP/NPT	10	150	54*35*28
		KAV0325B/N	1"BSP/NPT	10	150	54*35*28
		KAV0350B/N	2"BSP/NPT	1	70	54*35*28

技术参数 Technical Data:

- 接口规格: 3/4"BSP/NPT, 外螺纹
1"BSP/NPT, 外螺纹
2"BSP/NPT, 内螺纹
- 工作压力: 0.1-10Bar (1.5-150psi)
- 爆破压力: 20Bar (300psi)
- 使用温度: 1-60°C
- 主体材料: 聚丙烯 PP
- 密封材料: EPDM
- Size : 3/4"BSP/NPT, Male Thread
1"BSP/NPT, Male Thread
2"BSP/NPT, Female Thread
- Working Pressure : 0.1-10Bar (1.5-150psi)
- Burst Pressure: 20Bar (300psi)
- Working Temperature : 1-60°C
- Body Material : PP
- Seal Material : EPDM

尺寸 (Size)	重量		进排气口规格		
	DN	Inch	D(mm)	H(mm)	N.W.(kg)
20	3/4"	58	116	71	311
25	1"	58	119	73	311
50	2"	73	123	167	751

产品结构图 Part List:

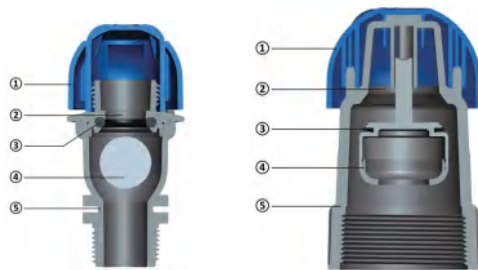

序号 Part	名称	Description
1	防护盖	Cover
2	进排气口	Kinetic Orifice
3	密封圈	Seal
4	浮球	Float
5	阀体	Body

进排气流量性能表 Air Flow Performance Charts:

进排气 (系统注水、排空、负压工况)

Air Relief and Intake (Pipeline Filling, Draining and Vacuum Conditions)

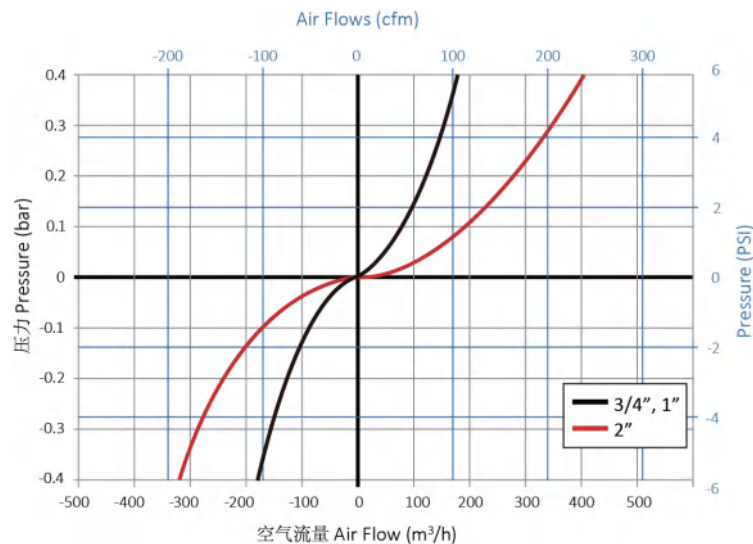

空气阀 Air & Vacuum Release Valve

特点 Features:

- 进排气空气阀，适用于各种灌溉系统应用，系统注水时，空气阀排出管道中大量空气；系统排空时，空气阀吸入大量空气防止真空负压。
- 阀门采用先进的复合气体动力学设计，具有快速进排气；可避免空气积聚，防止形成负压，低压时具有良好的密封性能。
- Air valve is applied for irrigation system or networks of water supply. It evacuates air during pipeline filling and enables large volume air intake in the event of network draining.
- With its advanced aerodynamic design and kinetic orifice, this valve can provide excellent protection against vacuum formation, with improved sealing under low pressure conditions.

应用范围 Application:

- 灌溉系统管网：排出灌溉系统中的空气，避免水泵下游、沿程输水管道以及管道上下坡位置形成负压。
- 灌溉首部：排出空气，防止过滤器、施肥罐处形成负压。
- 灌溉管道高处：排出空气，避免系统高处空气聚集破坏管道。
- Main Irrigation Networks - Air relief and vacuum prevention downstream of pumps, along supply lines and at elevations in main irrigation networks.
- Irrigation Control Heads - Air relief and vacuum prevention at filtration and fertilization stations.
- High part of Irrigation Pipeline System - Air relief, Prevention of pipe broken as for high pressure air.

产品名称 Product Description	图片 Picture	货号 Item No.	规格 Size	每袋数量 Qty/Bag (Pc)	每箱数量 Qty/Ctn (Pc)	纸箱规格 Ctn Size (Cm)	毛重 G.W (Kg)
快速排气阀 Air & Vacuum Release Valve		AV0112B	1/2" BSP	100	2800	54*35*28	21
快速排气阀 Air & Vacuum Release Valve		AV0134B/N	3/4" BSP/NTP	10	200	54*35*28	16
		AV0110B/N	1" BSP/NTP	10	180	54*35*28	18
组合式空气阀 Combination Air Valve		AV0120B/N	3/4" BSP/NTP	1	64	54*35*28	18
		AV0125B/N	1" BSP/NTP	1	64	54*35*28	18
		AV0140B/N	1-1/2" BSP/ NTP	1	64	54*35*28	18
组合式空气阀 Combination Air Valve		AV0150B/N	2" BSP/NTP	1	15	54*35*28	12

技术参数 Technical Data:

货号 Item No.	规格 Model	类型 Valve Type	工作压力范围 Pressure Range (Bar)	排气量 Air Outtake Flow (m ³ /h)	真空吸入量 Air Intake Flow (m ³ /h)
AV0112	1/2"	Kinetic Air & Vacuum Release Valve	0.3-10	0-35m ³ /h@0-0.4bar	-80-0m ³ /h @-0.4-0bar
AV0134/10	3/4"/1"	Kinetic Air & Vacuum Release Valve	0.3-10	0-50m ³ /h@0.0.35bar	-67-0m ³ /h @-0.35-0bar
AV0120/25/40	3/4"/1"/1-1/2"	Combination Air Valve	0.3-15	0-280m ³ /h@0.0.35bar	-280-0m ³ /h @-0.35-0bar
AV0150	2"	Combination Air Valve	0.3-15	0-360m ³ /h@0.0.35bar	-360-0m ³ /h @-0.35-0bar

进排气流量性能表 Air & Vacuum Flow Rate:

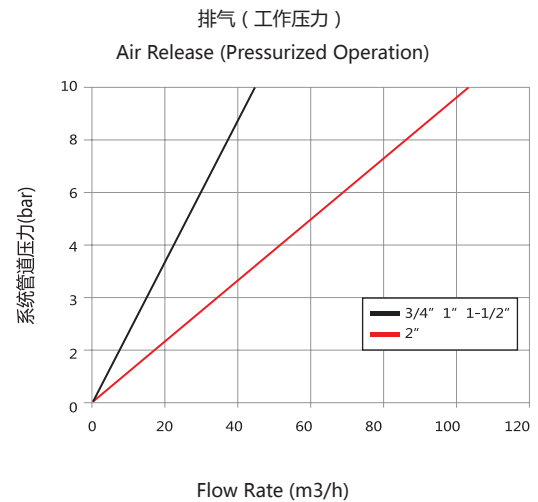
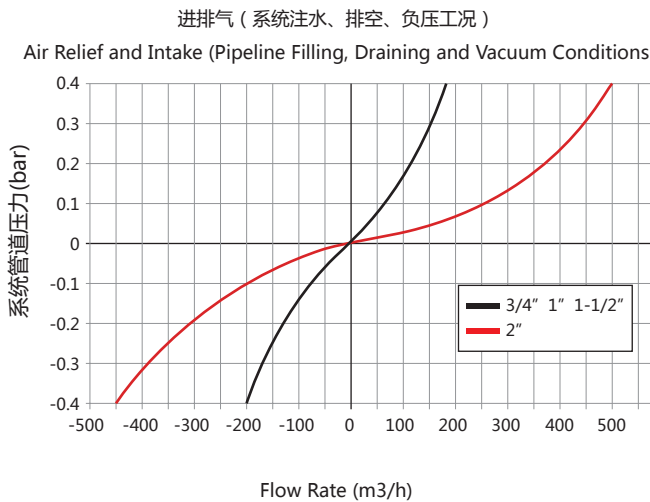

AV0120/25/40/50

排气 (工作压力) Air Release (Pressurized Operation)

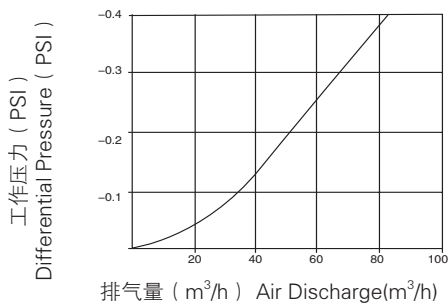

AV0112



文丘里注肥器 Venturi Fertilizer Injector

特点 Features:

- 主体一次性成型，结构合理。
- 进出水口为外螺纹接头，方便连接。
- 可与注肥器套件配合易于主管道相连接。
- 利用虹吸原理，方便吸入各种液态肥料并注入灌溉管道中，水肥均匀灌溉各种作物。
- Commercial grade one with no moving parts.
- It works by suction and will draw liquid fertilizer out of almost any container you provide.
- Can be plumbed on a bypass for less restriction(the preferred method),or directly into a main water line.
- All sizes have Male Pipe threads on the inlet and outlet, which are easily adapted to hose threads.

应用 Application:

- 按作物及灌溉面积挑选相应规格注肥器，太大或太小都不利于有效施肥。
- 如无法确定时，挑选规格小的然后与注肥套件配合与主管道并联安装通过调整阀门控制水量达到注肥目的；如果确定注肥器偏小可通过阀门调小水量通过延长达到施肥目的。
- Select the appropriate specification of fertilizer Injector depend on the crop and irrigation area. Too big or too small maybe do nothing.
- If in doubt always choose a smaller size, put it on a bypass assembly which allows you to adjust the flow through the venturi injector and does not restrict the flow as much.

产品名称 Product Description	图片 Picture	货号 Item No.	规格 Size	每袋数量 Qty/Bag (Pc)	每箱数量 Qty/Ctn (Pc)	纸箱规格 Ctn Size (Cm)	毛重 G.W (Kg)
文丘里式注肥器 Venturi Injector		VI0115B/N	1/2" BSP/NPT	10	300	54*35*28	11
		VI0120B/N	3/4" BSP/NPT	10	250	54*35*28	11
		VI0110HB/N	1" BSP/NPT	10	100	54*35*28	12
		VI0132HB/N	1-1/2" BSP/NPT	1	40	54*35*28	9
		VI0234B/N	3/4" BSP/NPT	1	40	54*35*28	5
		VI0250B/N	2" BSP/NPT	1	20	66*31*40	10
过滤吸管套件 Suction Assembly		SA021234	1/2" or 3/4"	1	60	54*35*28	9
		SA021032	1" or 1-1/2"	1	20	54*35*28	9
		SA0120	2"	1	10	54*35*28	10

技术参数 Technical Data:

进水压力 (m)	出水压力 (m)	VI0115B/N		VI0120B/N		VI0234B/N		VI0110H		VI0132H		VI0250B/N	
		流量 L/H	吸入量 L/H	流量 L/H	吸入量 L/H	流量 L/H	吸入量 L/H	流量 L/H	吸入量 L/H	流量 L/H	吸入量 L/H	流量 L/H	吸入量 L/H
14	3	399	67	771	99	493	142	3136	592	4712	564	8172	2075
	7		55		72		70		498		383		858
	8		46		55		44		405		346		-
21	3	462	71	944	107	690	204	3089	578	5575	655	10860	2766
	7		66		107		139		512		567		1897
	10		60		95		85		362		398		1105
	14		24		55		29		122		54		-
28	3	520	66	1024	112	823	204	3595	581	6411	718	12168	2988
	7		65		112		200		581		700		2686
	11		63		107		180		516		605		2116
	14		59		86		114		392		473		1074
	17		46		49		73		268		301		-
35	7	563	68	1129	123	914	211	4059	603	6950	711	13004	2974
	10		65		115		200		608		691		2668
	14		64		110		180		586		619		2063
	17		63		104		107		497		502		1373
	21		55		71		74		369		324		-
	24		32		39		42		213		117		-
42	7	607	66	1215	108	967	209	4178	589	8400	867	14117	3010
	14		65		117		199		576		862		2743
	17		65		110		154		549		780		2368
	21		64		106		110		428		690		1648
	24		61		91		88		311		560		-
	28		40		46		41		97		310		-
49	7	646	70	1283	111	1021	206	4778	608	9120	865	15278	2983
	14		67		112		201		601		863		2945
	21		65		109		156		587		854		2420
	24		64		106		135		556		761		1842
	28		64		94		92		439		750		-
	31		55		70		71		328		604		-
	35		23		42		35		130		471		-
56	7	691	68	1376	114	1097	221	5057	623	9744	876	16272	3031
	14		67		112		211		628		872		2954
	21		66		111		203		601		870		2828
	24		65		109		194		589		852		2453
	28		65		109		157		518		834		1878
	31		65		92		127		455		755		-
	35		60		70		99		329		714		-
	38		43		47		56		229		450		-
70	7	750	69	1466	118	1213	217	5561	356	10860	878	18204	3040
	14		68		110		216		356		872		2970
	21		67		110		212		342		867		3010
	28		67		110		202		338		863		2803
	42		64		75		112		336		852		-
	45		61		51		76		310		325		-
	49		31		16		52		305		186		-

LDPE 软管

- 采用优质聚乙烯原料生产，同时添加抗 UV 和抗老化剂更加耐用。
- 公制，有多种规格和压力等级可供选择。
- 主要运用于灌溉系统中的主管道和分支管道。

LDPE Tubing

- Polyethylene hose manufactured from the highest grade of polyethylene resins, which provide maximum resistance to UV degradation and stress cracking.
- Various diameters, coil lengths and working pressure are available for selection.
- Ideal for installation of mainline and sub-line in irrigation system.

产品名称 Product Description	货号 Item No.	产品名称 Product Description	单位 Unit	包装 Package (m/roll)	包装规格 Package Size (Cm)	毛重 G.W (Kg)
	LP011610	Dn16 , 1.0mm , 2.5Bar	m	500	Dn90*30	26
	LP011612	Dn16 , 1.2mm , 4.0Bar	m	500	Dn90*30	27
	LP011616	Dn16 , 1.6mm , 6.0Bar	m	500	Dn90*30	38
	LP012012	Dn20 , 1.2mm , 2.5Bar	m	200	Dn75*30	15
	LP012015	Dn20 , 1.5mm , 4.0Bar	m	200	Dn75*30	18
	LP012020	Dn20 , 2.0mm , 6.0Bar	m	200	Dn75*30	23
	LP020510	黑白管 White/Black PE pipe Dn5,1.0mm,5Bar	m	500	Dn45*60	8
	LP021610	黑白管 White/Black PE pipe Dn16,1.0mm,2.5Bar	m	500	Dn90*30	26
	LP021612	黑白管 White/Black PE pipe Dn5,1.2mm,4.0Bar	m	500	Dn90*30	27
	LP022013	黑白管 White/Black PE pipe Dn20,1.3mm,2.5Bar	m	200	Dn75*30	15
LP022015	黑白管 White/Black PE pipe Dn20,1.5mm,4.0Bar	m	200	Dn75*30	18	





备注：外层白色 PE 管可以有效防止太阳曝晒下管内水温升高，避免烫伤作物

Note: Under the sun exposure, the PE pipe with white color outside can be effective to prevent water from high temperature and avoid to hurt the crops.

拉扣式带用配件 Lock Ring Fitting for Drip Tape for 0.2–0.4mm Thickness

产品名称 Product Description	图片 Picture	货号 Item No.	规格 Size	每袋数量 Qty/Bag (Pc)	每箱数量 Qty/Ctn (Pc)	纸箱规格 Ctn Size (Cm)	毛重 G.W (Kg)
拉扣带用旁通接头 Lock Ring Offtake for Drip Tape		TO021715	Dn17*15	100	1600	54*35*28	14
PVC 管用拉扣旁通 (带单层橡胶圈) PVC Offtake for Drip Tape		TO021715R	Dn17*15	100	1400	54*35*28	15
拉扣带用直接 Lock Ring Coupling for Drip Tape		LC0217	Dn17	100	1300	54*35*28	12
拉扣带用承插接头 Barb Lock Ring Coupling for Drip Tape		BC021617	Dn17*16	100	1600	54*35*28	11
拉扣带用接头 Lock Ring Tape Plug		TP0317	Dn17	100	2000	54*35*28	11
大单层橡胶圈 T Grommet		RR011613	Dn16*13	100	7000	54*35*28	21

锁扣式带用配件 Lock Nut Fitting for Drip Tape for 0.2–0.6mm Thickness

产品名称 Product Description	图片 Picture	货号 Item No.	规格 Size	每袋数量 Qty/Bag (Pc)	每箱数量 Qty/Ctn (Pc)	纸箱规格 Ctn Size (Cm)	毛重 G.W (Kg)
带用旁通接头 Tape Offtake		TO011715	Dn17*15	100	1300	54*35*28	14
带用旁通 (带单层橡胶圈) PVC Offtake for Tape		TO011715R	Dn17*15	100	1000	54*35*28	14
带用锁扣旁通 Lock Type Offtake		LO0117	Dn17	100	1000	54*35*28	13
带用锁扣直接 Lock Coupling for Tape		LC0117	Dn17	100	800	54*35*28	14
带用承插接头 Barbed Coupling for Tape		BC011617	Dn17*16	100	1100	54*35*28	14
外螺纹带用接头 Male Thread Coupling for Tape		MT011712	Dn17*1/2"	100	1000	54*35*28	14
		MT011734	Dn17*3/4"	100	900	54*35*28	14

产品名称 Product Description	图片 Picture	货号 Item No.	规格 Size	每袋数量 Qty/Bag (Pc)	每箱数量 Qty/Ctn (Pc)	纸箱规格 Ctn Size (Cm)	毛重 G.W (Kg)
可折式带用涂塑软管旁通接头 Connection for Lay Flat Hose		CT0217	Dn17	100	550	54*35*28	16
涂塑软管快速带用接头 Croco Offtake for Lay Flat Hose		CT0317	Dn17	100	700	54*35*28	19
带用锁扣弯头 Lock Elbow for Tape		ET0117	Dn17	100	700	54*35*28	14
三边锁扣带用三通 Lock Tee for Tape		TT0117	Dn17	50	350	54*35*28	12
外螺纹带用三通 Male Threaded Tape Tee		TT021712	Dn17*1/2"	50	450	54*35*28	12
可折式带用涂塑软管三通接头 Tape Tee for Lay Flat Hose		TT0417	Dn17	50	250	54*35*28	11
锁扣式带用堵头 Tape Plug		TP0117	Dn17	100	1300	54*35*28	18

滴灌带用阀门 Mini Valve for Drip Tape

产品名称 Product Description	图片 Picture	货号 Item No.	规格 Size	每袋数量 Qty/Bag (Pc)	每箱数量 Qty/Ctn (Pc)	纸箱规格 Ctn Size (Cm)	毛重 G.W (Kg)
带用旁通阀门 Offtake Tape Valve		OV031715	Dn17*15	50	500	54*35*28	15
带用旁通阀门 (带单层橡胶圈) Offtake Tape Valve with T Grommet		OV031715R	Dn17*15	50	450	54*35*28	17
承插带用阀门 Barb-Lock Vale for Tape		BV011617	Dn16*17	50	450	54*35*28	16
带用锁扣旁通阀门 Offtake Valve for Tape		OV0217	Dn17	50	450	54*35*28	16
多功能 带用管用阀门 Multi Valve for Drip Tape and Pipe		MV021617	Dn16*17	50	400	54*35*28	17
外螺纹带用阀门 Male Thread Valve for Tape		TV0117	Dn17*1/2"	50	450	54*35*28	16
双边带用锁扣阀门 Lock Tape Coupler with Valve		LV0117	Dn17	50	400	54*35*28	17
涂塑软管 旁通带用阀门 Tape Valve for Lay Flat Hose		TV0217	Dn17	50	300	54*35*28	16

微灌管用配件 Fitting for Tubing

产品名称 Product Description	图片 Picture	货号 Item No.	规格 Size	每袋数量 Qty/Bag	每箱数量 Qty/Ctn (Pc)	纸箱规格 Ctn Size (Cm)	毛重 G.W (Kg)
管用旁通接头 Offtake for PE Pipe		OP011615	Dn16*15	100	2800	54*35*28	16
		OP012015	Dn20*15	100	1400	54*35*28	14
管用旁通接头 (带大单层橡胶圈) Offtake for PVC Pipe		OP011615R	Dn16*15	100	2200	54*35*28	18
		OP012015R	Dn20*15	100	1200	54*35*28	16
PVC 管用旁通三通 Offtake Tee for PVC Pipe		OT0116R	Dn16*15	100	1200	54*35*28	10
外螺纹管用接头 Male Threaded Connector		MC011612	Dn16*1/2"	100	1900	54*35*28	15
		MC011634	Dn16*3/4"	100	1200	54*35*28	12
管用倒刺弯头 Elbow Connector		EC0116	Dn16	100	2100	54*35*28	10
		EC0120	Dn20	50	1200	54*35*28	12
外螺纹管用倒刺弯头 Elbow With Male Thread		EC021612	Dn16*1/2"	100	1500	54*35*28	15
管用倒刺三通 Tee Connector		TC0116	Dn16	100	1300	54*35*28	10
		TC0120	Dn20	50	700	54*35*28	10
折叠式管用堵头 End Line		EL0116	Dn16	100	3000	54*35*28	11
		EL0120	Dn20	100	1600	54*35*28	12

备注：Dn17 配件专门用于 0.8 薄壁滴灌管。
Note: Dn17 Barb fitting is specialized to fit for Dripline with 0.8mm thickness.

微灌管用配件 Fitting for Tubing

产品名称 Product Description	图片 Picture	货号 Item No.	规格 Size	每袋数量 Qty/Bag (Pc)	每箱数量 Qty/Ctn (Pc)	纸箱规格 Ctn Size (Cm)	毛重 G.W (Kg)
地插固定支架 Holddown Support		HS0216	Dn16	100	4000	54*35*28	28
悬挂固定管夹 Hanging Clamp for PE pipe		HC0216	Dn16-17	500	15000	54*35*28	14
		HC0316	Dn16	500	8000	54*35*28	13
冲洗阀 Flush Valve		FV0234	3/4", 0.18bar	100	1200	54*35*28	13

锁扣管用接头 Lock Nut Fitting for Pipe

产品名称 Product Description	图片 Picture	货号 Item No.	规格 Size	每袋数量 Qty/Bag (Pc)	每箱数量 Qty/Ctn (Pc)	纸箱规格 Ctn Size (Cm)	毛重 G.W (Kg)
锁扣管用旁通 Lock Offtake for Pipe		OP021615	Dn16*15	100	1300	54*35*28	15
内螺纹锁扣接头 Lock Coupling with Female Thread		FC021634	Dn16*3/4"	100	1000	54*35*28	12
外螺纹锁扣接头 Lock Coupling with Male Thread		MC021612	Dn16*1/2"	100	1200	54*35*28	14
		MC021634	Dn16*3/4"	100	1000	54*35*28	12
锁扣管用直通 Lock Coupling for Pipe		SC0216	Dn16	100	900	54*35*28	14
锁扣管用弯头 Lock Elbow for Pipe		EC0216	Dn16	100	700	54*35*28	12
管用锁扣三通 Lock Tee for Pipe		TC0216	Dn16	50	400	54*35*28	11
锁扣管用堵头 Lock Plug for Pipe		EL0316	Dn16	100	1300	54*35*28	13

锁扣管用接头 Dn20 Lock Nut Fitting for Pipe Dn20

产品名称 Product Description	图片 Picture	货号 Item No.	规格 Size	每袋数量 Qty/Bag (Pc)	每箱数量 Qty/Ctn (Pc)	纸箱规格 Ctn Size (Cm)	毛重 G.W (Kg)
锁扣管用旁通 Lock Offtake for Pipe		OP032018	Dn20*18	50	600	54*35*28	11
锁扣管用直接 Lock Coupling for Pipe		SC0320	Dn20	50	400	54*35*28	13
锁扣变接 Lock Adaptor with Male thread		MC032034	Dn20*3/4"	50	550	54*35*28	11
锁扣弯头 Lock Elbow		EC0320	Dn20	50	300	54*35*28	10
锁扣正三通 Lock Tee		TC0320	Dn20	25	200	54*35*28	10
锁扣三通变接 Lock Tee with Male Thread		TC032034	Dn20*3/4"	25	200	54*35*28	9
锁扣堵头 Lock End line		EL0320	Dn20	50	400	54*35*28	13
锁扣直通阀门 Lock Joint Valve		MV0320	Dn20	25	200	54*35*28	11
锁扣变接阀门 Thread- Lock Valve		TV032034	Dn20*3/4"	30	300	54*35*28	13
锁扣旁通阀门 Lock Offtake Valve		OV032018	Dn20*18	30	300	54*35*28	13
橡胶大单层胶圈 T Rubbee Grommet		RR012018	T20*Dn18	100	5000	54*35*28	16

微灌管用阀门 Mini Valve for Tubing

产品名称 Product Description	图片 Picture	货号 Item No.	规格 Size	每袋数量 Qty/Bag (Pc)	每箱数量 Qty/Ctn (Pc)	纸箱规格 Ctn Size (Cm)	毛重 G.W (Kg)
承插旁通阀门 Barb Offtake Valve		OV011615	Dn16*15	50	600	54*35*28	16
		OV012015	Dn20*15	50	550	54*35*28	15
锁扣旁通阀门 Lock Offtake Valve		OV021615	Dn16*15	50	500	54*35*28	17
承插直通阀门 Maxi Valve		MV0116	Dn16	50	600	54*35*28	15
		MV0120	Dn20	50	500	54*35*28	12
锁扣直通阀门 Lock Joint Valve		MV0216	Dn16	50	350	54*35*28	14
外螺纹承插阀门 Thread-barb Valve		TV011216	Dn1/2"*16	50	600	54*35*28	16
		TV011220	Dn1/2"*20	50	550	54*35*28	14

管用配套工具及其他 Accessory Tooling for Tubing

产品名称 Product Description	图片 Picture	货号 Item No.	规格 Size	每袋数量 Qty/Bag (Pc)	每箱数量 Qty/Ctn (Pc)	纸箱规格 Ctn Size (Cm)	毛重 G.W (Kg)
管上式打孔器 Punch for On-line Dripper		PD0104	Dn4	100	3500	42*28*21	13
简易打孔器 Simple Punch		SP0103	Dn3	10	400	54*35*28	28
		SP0108	Dn8	10	400	54*35*28	28
实芯打孔器 Simple Punch		SP0203	Dn3	100	400	54*35*28	28
握式打孔器 Handle Punch		SP250	Dn3	1	60	42*28*21	8
涂塑软管打孔器 Punch for Lay Flat Hose		PF0215	Dn15	1	50	42*28*21	9
		PF0217	Dn17	1	50	42*28*21	9
多功能钻头 Multi Size Drill		SP0616	Dn6-16	1	200	42*28*21	10
		SP0620	Dn6-20	1	200	42*28*21	12